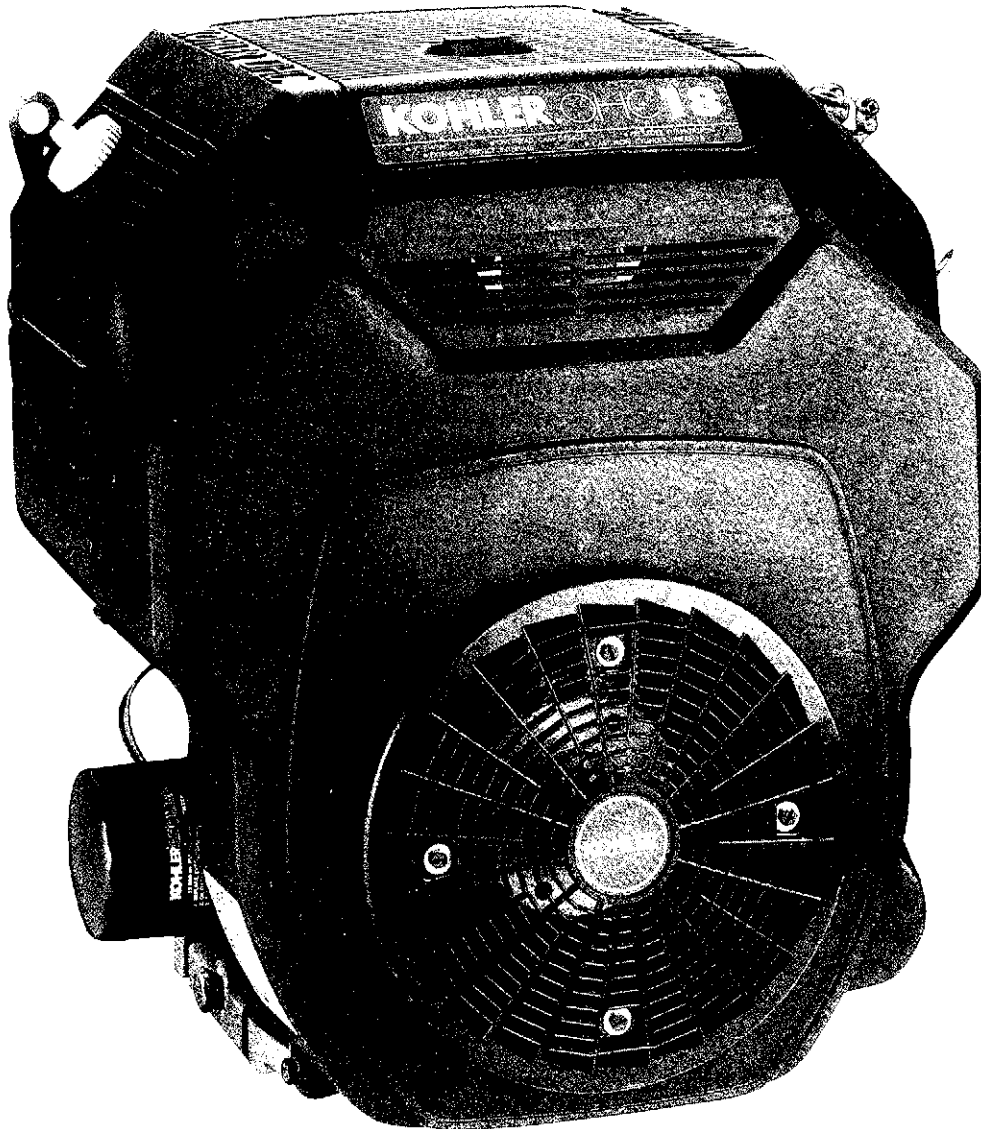


**KOHLER**engines

***SERVICE MANUAL***  
***OHC 16,18 HP***  
**Horizontal Crankshaft**



OHC

# Contents

---

<b>Section 1. Safety and General Information .....</b>	<b>1</b>
<b>Section 2. Special Tools .....</b>	<b>2</b>
<b>Section 3. Troubleshooting .....</b>	<b>3</b>
<b>Section 4. Air Cleaner and Air Intake System .....</b>	<b>4</b>
<b>Section 5. Fuel System and Governor .....</b>	<b>5</b>
<b>Section 6. Lubrication System .....</b>	<b>6</b>
<b>Section 7. Retractable Starter .....</b>	<b>7</b>
<b>Section 8. Electrical System and Components .....</b>	<b>8</b>
<b>Section 9. Disassembly .....</b>	<b>9</b>
<b>Section 10. Inspection and Reconditioning .....</b>	<b>10</b>
<b>Section 11. Reassembly .....</b>	<b>11</b>

---

# Section 1

## Safety and General Information

### Safety Precautions

To insure safe operations please read the following statements and understand their meaning. Also refer to your equipment manufacturer's manual for other important safety information. This manual contains safety precautions which are explained below. Please read carefully.

#### **WARNING**

Warning is used to indicate the presence of a hazard that *can* cause *severe* personal injury, death, or substantial property damage if the warning is ignored.

#### **CAUTION**

Caution is used to indicate the presence of a hazard that *will* or *can* cause *minor* personal injury or property damage if the warning is ignored.

#### **NOTE**

Note is used to notify people of installation, operation, or maintenance information that is important but not hazard-related.

#### **For Your Safety!**



*These precautions should be followed at all times. Failure to follow these precautions could result in injury to yourself and others.*

 <b>WARNING</b>

<b>Accidental Starts can cause severe injury or death.</b>
Disconnect and ground spark plug leads before servicing.



#### **Accidental Starts!**

*Before servicing the engine or equipment, always disconnect the spark plug leads to prevent the engine from starting accidentally. Ground the leads to prevent sparks that could cause fires. Make sure the equipment is in neutral.*

 <b>WARNING</b>

<b>Rotating Parts can cause severe injury.</b>
Stay away while engine is in operation.

#### **Rotating Parts!**



*Keep hands, feet, hair, and clothing away from all moving parts to prevent injury. Never operate the engine with covers, shrouds, or guards removed.*

 <b>WARNING</b>

<b>Hot Parts can cause severe burns.</b>
Do not touch engine while operating or just after stopping.

#### **Hot Parts!**

*Engine components can get extremely hot from operation. To prevent severe burns, do not touch these areas while the engine is running—or immediately after it is turned off. Never operate the engine with heat shields or guards removed.*

## Section 1 Safety and General Information

 <b>WARNING</b>

<b>Explosive Fuel can cause fires and severe burns.</b>
Stop engine before filling fuel tank.

### Explosive Fuel!



Gasoline is extremely flammable and its vapors can explode if ignited. Store gasoline only in approved containers, in well ventilated, unoccupied buildings, away from sparks or flames. Do not fill the fuel tank while the engine is hot or running, since spilled fuel could ignite if it comes in contact with hot parts or sparks from ignition. Do not start the engine near spilled fuel. Never use gasoline as a cleaning agent.

 <b>WARNING</b>

<b>Cleaning Solvents can cause severe injury or death.</b>
Use only in well ventilated areas away from ignition sources.

### Flammable Solvents!

Carburetor cleaners and solvents are extremely flammable. Keep sparks, flames, and other sources of ignition away from the area. Follow the cleaner manufacturer's warnings and instructions on its proper and safe use. Never use gasoline as a cleaning agent.

 <b>WARNING</b>

<b>Carbon Monoxide can cause severe nausea, fainting, or death.</b>
Do not operate engine in closed or confined area.

### Lethal Exhaust Gases!



Engine exhaust gases contain poisonous carbon monoxide. Carbon monoxide is odorless, colorless, and can cause death if inhaled. Avoid inhaling exhaust fumes, and never run the engine in a closed building or confined area.

 <b>WARNING</b>

<b>Uncoiling Spring can cause severe injury.</b>
Wear safety goggles or face protection when servicing retractable starter.

### Spring Under Tension!



Retractable starters contain a powerful recoil spring that is under tension. Always wear safety goggles when servicing retractable starters and carefully follow instructions in "Retractable Starter" Section 7 for relieving spring tension.

 <b>WARNING</b>

<b>Explosive Gas can cause fires and severe acid burns.</b>
Charge battery only in a well ventilated area. Keep sources of ignition away.

### Explosive Gas!

Batteries produce explosive hydrogen gas while being charged. To prevent a fire or explosion, charge batteries only in well ventilated areas. Keep sparks, open flames, and other sources of ignition away from the battery at all times. Keep batteries out of the reach of children. Remove all jewelry when servicing batteries.

Before disconnecting the negative (-) ground cable, make sure all switches are OFF. If ON, a spark will occur at the ground cable terminal, which could cause an explosion if hydrogen gas or gasoline vapors are present.

 <b>CAUTION</b>

<b>Electrical Shock can cause injury.</b>
Do not touch wires while engine is running.

### Electrical Shock!

Never touch electrical wires or components while the engine is running. They can be sources of electrical shock.

**Engine Identification Numbers**

When ordering parts, or in any communication involving an engine, always give the **Model, Specification and Serial Numbers**, including letter suffixes if there are any.

The engine identification numbers appear on a decal, or decals, affixed to the engine shrouding. See Figure 1-1. An explanation of these numbers is shown in Figure 1-2.

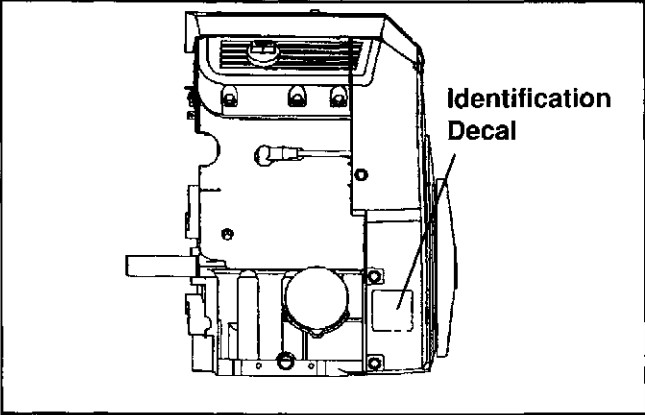


Figure 1-1. Engine Identification Decal Location.

**A. Model No. TH16S**

Twin Cylinder Engine	TH	16	S
Horizontal Crankshaft			Version Code
Horsepower			S = Electric Start
16 = 16 HP			
18 = 18 HP			

**B. Spec. No. 52501**

Engine Model Code	52	50	1
<u>Code</u> <u>Model</u>	Variation of Basic Engine		
52    TH16			
54    TH18			

**C. Serial No. 2605810332**

<u>Year</u>	<u>Manufactured</u>	2605810332	2
26	1996	Factory Code	
27	1997		
28	1998		
29	1999		
30	2000		

Figure 1-2. Explanation of Engine Identification Numbers.

# Section 1

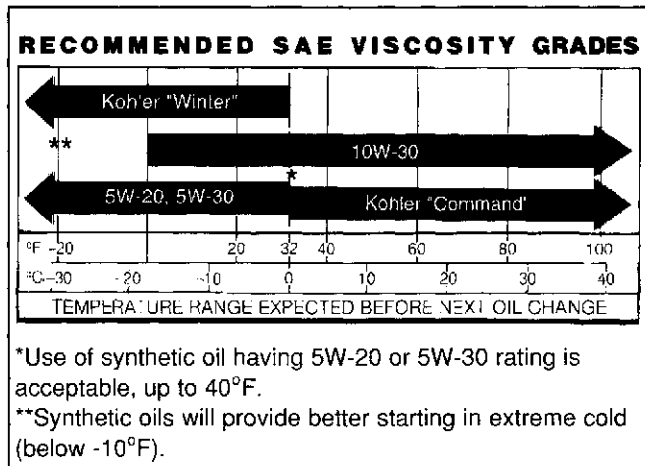
## Safety and General Information

### Oil Recommendations

Using the proper type and weight of oil in the crankcase is extremely important. So is checking oil daily and changing oil regularly. Failure to use the correct oil, or using dirty oil, causes premature engine wear and failure.

#### Oil Type

Use high-quality detergent oil of **API (American Petroleum Institute) Service class SG or SH**. Select the viscosity based on the air temperature at the time of operation as shown in the following table.



NOTE: Using other than service class SG or SH oil or extending oil change intervals longer than recommended can cause engine damage.

A logo or symbol on oil containers identifies the API service class and SAE viscosity grade. See Figure 1-3.

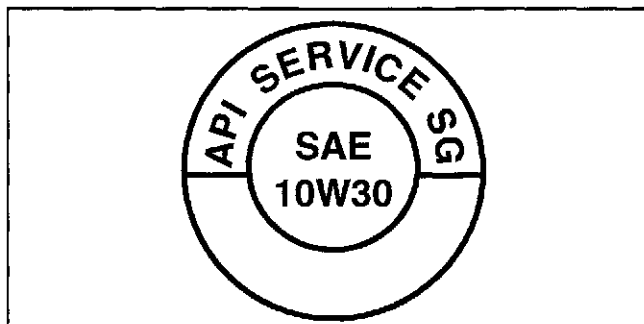


Figure 1-3. Oil Container Logo.

Refer to Section 6 - "Lubrication System" for detailed procedures on checking the oil, changing the oil, and changing the oil filter.

### Fuel Recommendations



#### WARNING: Explosive Fuel!

Gasoline is extremely flammable and its vapors can explode if ignited. Store gasoline only in approved containers, in well ventilated, unoccupied buildings, away from sparks or flames. Do not fill the fuel tank while the engine is hot or running, since spilled fuel could ignite if it comes in contact with hot parts or sparks from ignition. Do not start the engine near spilled fuel. Never use gasoline as a cleaning agent.

#### General Recommendations

Purchase gasoline in small quantities and store in clean, approved containers. A container with a capacity of 2 gallons or less with a pouring spout is recommended. Such a container is easier to handle and helps eliminate spillage during refueling.

Do not use gasoline left over from the previous season, to minimize gum deposits in your fuel system and to ensure easy starting.

Do not add oil to gasoline.

Do not overfill the fuel tank. Leave room for the fuel to expand

#### Fuel Type

For best results, use only clean, fresh, unleaded gasoline with a pump sticker octane rating of 87 or higher. In countries using the Research method, it should be 90 octane minimum.

Unleaded gasoline is recommended, as it leaves fewer combustion chamber deposits.

#### Gasoline/Alcohol blends

Gasohol (up to 10% ethyl alcohol, 90% unleaded gasoline by volume) is approved as a fuel for Kohler engines. Other gasoline/alcohol blends are not approved.

#### Gasoline/Ether blends

Methyl Tertiary Butyl Ether (MTBE) and unleaded gasoline blends (up to a maximum of 15% MTBE by volume) are approved as a fuel for Kohler engines. Other gasoline/ether blends are not approved.

## Periodic Maintenance



### **WARNING: Accidental Starts!**

*Before servicing the engine or equipment, always disconnect the spark plug leads to prevent the engine from starting accidentally. Ground the leads to prevent sparks that could cause fires. Make sure the equipment is in neutral.*

## Maintenance Schedule

These required maintenance procedures should be performed at the frequency stated in the table. They should also be included as part of any seasonal tune-up.

Frequency	Maintenance Required	Refer to:
<b>Daily or Before Starting Engine</b>	Fill fuel tank. Check oil level. Check air cleaner for dirty, loose, or damaged parts. Check air intake and cooling areas; clean as necessary <sup>1</sup> .	Section 5 Section 6 Section 4 Section 4
<b>Every 25 Hours</b>	Service precleaner element <sup>1</sup> .	Section 4
<b>Every 100 Hours</b>	Replace air cleaner element <sup>1</sup> . Change engine oil. Remove cooling shrouds and clean cooling areas <sup>1</sup> .	Section 4 Section 6 Section 4
<b>Every 200 Hours</b>	Change oil filter. Check spark plug condition and gap.	Section 6 Section 8
<b>Annually or Every 500 Hours</b>	Have bendix starter drive serviced <sup>2</sup> . Have solenoid shift starter disassembled and cleaned <sup>2</sup> .	Section 8 Section 8

<sup>1</sup>Perform these maintenance procedures more frequently under extremely dusty, dirty conditions.

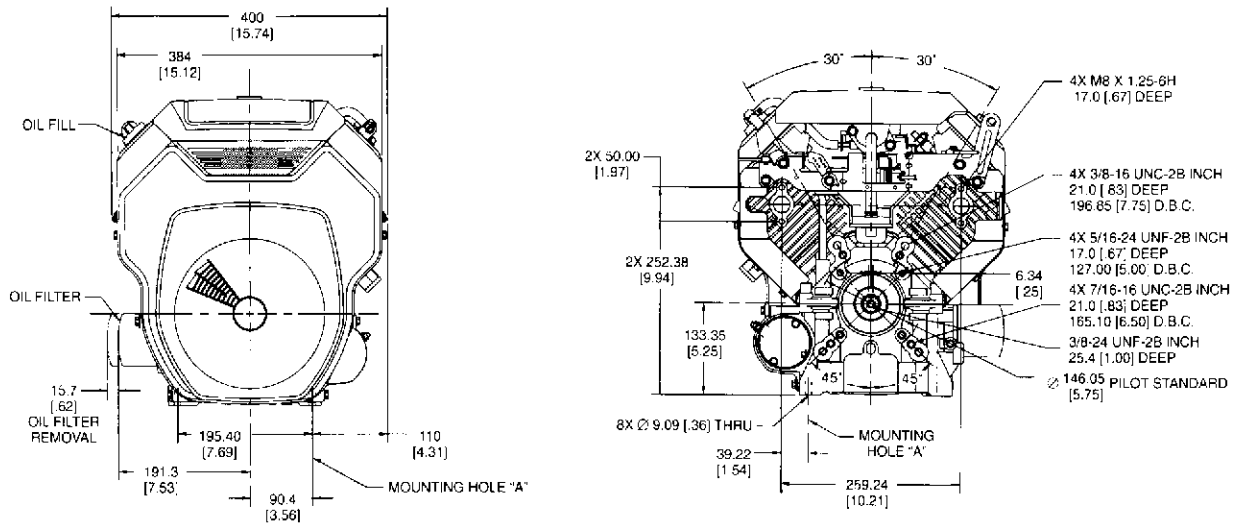
<sup>2</sup>Have a Kohler Engine Service Dealer perform this service.

## Storage

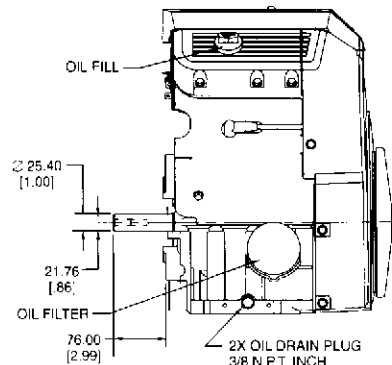
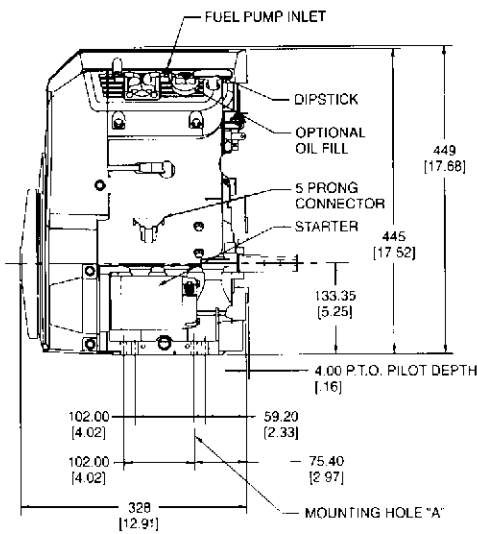
If the engine will be out of service for two months or more, use the following storage procedure:

1. Clean the exterior surfaces of the engine.
2. Change the oil and oil filter while the engine is still warm from operation. See "Change Oil and Oil Filter" in Section 6.
3. The fuel system must be completely emptied, or the gasoline must be treated with a stabilizer to prevent deterioration. If you choose to use a stabilizer, follow the manufacturer's recommendations, and add the correct amount for the capacity of the fuel system. Fill the fuel tank with clean, fresh gasoline. Run the engine for 2 to 3 minutes to get stabilized fuel into the carburetor. To empty the system, run the engine until the tank and system are empty.
4. Remove the spark plugs and add one tablespoon of engine oil into each spark plug hole. Install plugs and ground spark plug leads-do not connect the leads to the plug. Crank the engine two or three revolutions.
5. Store the engine in a clean, dry place.

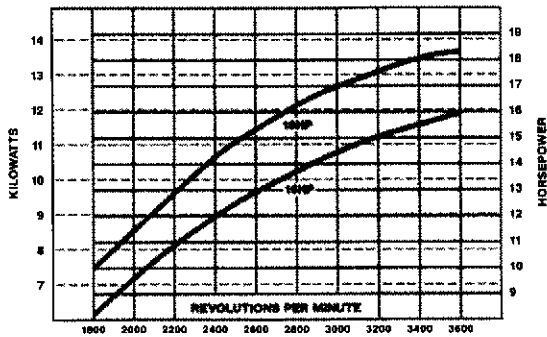
# Section 1 Safety and General Information



DIMENSIONS IN MILLIMETERS.  
INCH EQUIVALENTS SHOWN IN [ ].



**HP**



**Torque**

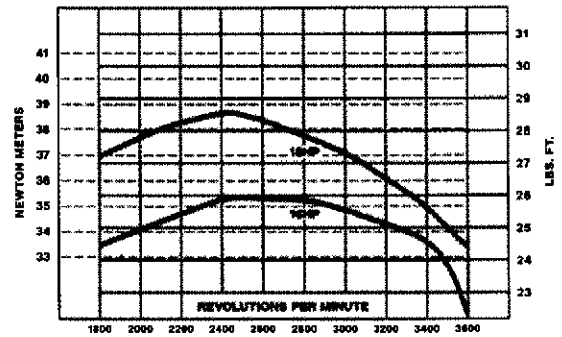


Figure 1-4. Typical Engine Dimensions, Torque, and Horsepower Curves OHC 16-18 HP.



## Section 1 Safety and General Information

Description	TH16 & TH18
<b>General Specifications<sup>1</sup></b>	
Power (@ 3600 RPM, corrected to SAE J1349)	
TH16 .....	11.9 kW (16 HP)
TH18 .....	13.4 kW (18 HP)
Peak Torque (See Torque Curve) @ 2500 RPM	
TH16 .....	35.5 N·m (26.2 ft. lb.)
TH18 .....	40 N·m (29.5 ft. lb.)
Bore	
TH16 .....	73 mm (2.87 in.)
TH18 .....	75 mm (2.95 in.)
Stroke	
TH16 .....	62 mm (2.44 in.)
TH18 .....	65 mm (2.56 in.)
Displacement	
TH16 .....	519cc (31.7 cu. in.)
TH18 .....	574cc (35.0 cu. in.)
Compression Ratio	
TH16 .....	7.8:1
TH18 .....	8.4:1
Dry Weight .....	43 kg (90 lb.)
Oil Capacity (with filter) .....	1.4 L (1.5 U.S. qt.)
Angle of Operation - Maximum (At Full Oil Level) All Directions .....	25°
<b>Blower Housing and Sheet Metal</b>	
M5 Fasteners Torque .....	4.0 N·m (35 in. lb.)
M6 Fasteners Torque (into crankcase) .....	7.3 N·m (65 in. lb.)
M6 Fasteners Torque (into sheet baffle) .....	4.0 N·m (35 in. lb.)
Rectifier Fastener Torque .....	4.0 N·m (35 in. lb.)
<b>Camshaft</b>	
End Play	
#1 Side .....	0.000/0.700 mm (0.000/0.0275 in.)
#2 Side .....	0.000/1.300 mm (0.000/0.0512 in.)
Running Clearance .....	0.025/0.105 mm (0.0010/0.0041 in.)
Bore I.D.	
New	
Front .....	32.000/32.025 mm (1.2598/1.2608 in.)
Rear .....	24.800/24.825 mm (0.9764/0.9774 in.)

<sup>1</sup>Values are in Metric units. Values in parentheses are English equivalents. Lubricate threads with engine oil prior to assembly.

## Section 1

### Safety and General Information

---

#### Camshaft (Cont.)

##### Bore I.D. (Cont.)

###### Max. Wear Limit

Front .....	32.04 mm (1.2614 in.)
Rear .....	24.84 mm (0.9779 in.)

##### Camshaft Bearing Surface O.D.

###### New

Front .....	31.920/31.975 mm (1.2567/1.2589 in.)
Rear .....	24.720/24.775 mm (0.9732/0.9754 in.)

###### Max. Wear Limit

Front .....	31.91 mm (1.2562 in.)
Rear .....	24.71 mm (0.9728 in.)

#### Carburetor

Carburetor Mounting Fasteners Torque ..... 9.9 N·m (88 in. lb.)

Carburetor Adjustments ..... Non-Adjustable Idle Fuel and Main Fuel

#### Connecting Rod

##### Cap Fastener Torque (torque in increments)

6 mm step-down ..... 11.3 N·m (100 in. lb.)

##### Connecting Rod-to-Crankpin Running Clearance

New .....	0.056/0.030 mm (0.0022/0.0012 in.)
Max. Wear Limit .....	0.07 mm (0.0028 in.)

Connecting Rod-to-Crankpin Side Clearance ..... 0.250/0.740 mm (0.0098/0.0291 in.)

##### Piston Pin End I.D.

New .....	17.015/17.023 mm (0.6699/0.6702 in.)
Max. Wear Limit .....	17.04 mm (0.6708 in.)

#### Crankcase

##### Governor Cross Shaft Bore I.D.

New .....	8.025/8.050 mm (0.3159/0.3169 in.)
Max. Wear Limit .....	8.07 mm (0.3177 in.)

Breather Cover Mounting Fasteners ..... 5.6 N·m (50 in. lb.)

Oil Drain Plugs ..... 13.6 N·m (10 ft. lb.)

Crankcase Halves Mounting Screw Torque ..... 24.4 N·m (216 in. lb.)

#### Crankshaft

End Play ..... Not Adjustable

##### Crankshaft Sleeve Bearing I.D.

New .....	45.071/45.111 mm (1.7744/1.7760 in.)
Max. Wear Limit .....	45.12 mm (1.7764 in.)

##### Crankshaft to Sleeve Bearing

Running Clearance - New ..... 0.030/0.090 mm (0.0012/0.0035 in.)

**Crankshaft (Cont.)**

**Flywheel End Main Bearing Journal**

O.D. - New .....	45.021/45.041 mm (1.7725/1.7735 in.)
O.D. - Max. Wear Limit .....	44.95 mm (1.7696 in.)
Max. Taper .....	0.02 mm (0.0008 in.)
Max. Out-of-Round .....	0.02 mm (0.0008 in.)

**PTO End Main Bearing Journal**

O.D. - New .....	45.021/45.041 mm (1.6107/1.6116 in.)
O.D. - Max. Wear Limit .....	44.95 mm (1.7696 in.)
Max. Taper .....	0.02 mm (0.0008 in.)
Max. Out-of-Round .....	0.02 mm (0.0008 in.)

**Connecting Rod Journal**

O.D. - New .....	31.948/31.966 mm (1.2578/1.2585 in.)
O.D. - Max. Wear Limit .....	31.93 mm (1.2571 in.)
Max. Taper .....	0.02 mm (0.0008 in.)
Max. Out-of-Round .....	0.02 mm (0.0008 in.)

**Crankshaft T.I.R.**

PTO End, Crank in Engine .....	0.015 mm (0.0006 in.)
Entire Crank, in V-Blocks .....	0.010 mm (0.0004 in.)

**Cylinder Bore**

**Cylinder Bore I.D.**

<b>New</b>	
TH16 .....	73.006/73.031 mm (2.8742/2.8752 in.)
TH18 .....	75.025/75.050 mm (2.9537/2.9547 in.)
<b>Max. Wear Limit</b>	
TH16 .....	73.07 mm (2.8767 in.)
TH18 .....	75.09 mm (2.9563 in.)
Max. Out-of-Round .....	0.13 mm (0.005 in.)
Max. Taper .....	0.13 mm (0.005 in.)

**Electric Starter**

Starter Mounting Fastener Torque .....	7.9 N·m (70 in. lb.)
--	----------------------

**Timing Belt**

Belt Tensioner Mounting Screw Torque .....	7.3 N·m (65 in. lb.)
Belt Tension Torque .....	3.4/4.5 N·m (30/40 in. lb.)

**Fan/Flywheel**

Fan Fastener Torque .....	9.9 N·m (88 in. lb.)
Flywheel Retaining Screw Torque .....	66.4 N·m (49 ft. lb.)

**Governor**

**Governor Cross Shaft to Crankcase**

Running Clearance .....	0.013/0.075 mm (0.0005/0.0030 in.)
-------------------------	------------------------------------

**Governor Cross Shaft O.D.**

New .....	7.975/8.012 mm (0.3140/0.3154 in.)
Max. Wear Limit .....	7.96 mm (0.3134 in.)

# Section 1

## Safety and General Information

---

### Governor (Cont.)

Governor Bushing to Camshaft  
Running Clearance ..... 0.045/0.160 mm (0.0018/0.0063 in.)

Governor Bushing I.D.  
New ..... 32.020/32.080 mm (1.2606/1.2630 in.)  
Max. Wear Limit ..... 32.09 mm (1.2634 in.)

### Ignition

Spark Plug Type (Champion® or Equivalent) ..... RC12YC

Spark Plug Gap ..... 0.76 mm (0.030 in.)

Spark Plug Torque ..... 24.4/29.8 N·m (18/22 ft. lb.)

Ignition Module Air Gap ..... 0.20/0.30 mm (0.008/0.012 in.)

Ignition Module Fastener Torque ..... 4.0/6.2 N·m (35/55 in. lb.)

### Muffler

Muffler Retaining Nuts Torque ..... 24.4 N·m (216 in. lb.)

### Oil Filter

Oil Filter Torque ..... 5.6/9.0 N·m (50/80 in. lb.)

Oil Filter Nipple Torque ..... 40.7 N·m (30 ft. lb.)

Oil Sentry™ Pressure Switch ..... 3.4 N·m (30 in. lb.)

### Piston, Piston Rings, and Piston Pin

Piston Pin Bore to Piston Pin (Select Fit) ..... 0.006/0.016 mm (0.0002/0.0007 in.)

Piston Pin Bore I.D.  
New ..... 17.006/17.012 mm (0.6695/0.6698 in.)  
Max. Wear Limit ..... 17.025 mm (0.6703 in.)

Piston Pin O.D.  
New ..... 16.996/17.000 mm (0.6691/0.6693 in.)  
Max. Wear Limit ..... 16.995 mm (0.6691 in.)

### Top Compression Ring-to-Groove Side Clearance

TH16 ..... 0.040/0.085 mm (0.0016/0.0033 in.)  
TH18 ..... 0.040/0.085 mm (0.0016/0.0033 in.)

### Middle Compression Ring-to-Groove Side Clearance

TH16 ..... 0.030/0.080 mm (0.0012/0.0031 in.)  
TH18 ..... 0.030/0.076 mm (0.0012/0.0030 in.)

### Oil Control Ring-to-Groove Side Clearance

TH16 ..... 0.046/0.201 mm (0.0018/0.0079 in.)  
TH18 (min.) ..... 0.070 mm (0.0028 in.)

Top Compression Ring End Gap ..... 0.180/0.380 mm (0.0071/0.0150 in.)

---

**Piston, Piston Rings, and Piston Pin (Cont.)**

**Middle Compression Ring End Gap**

TH16 .....	0.180/0.440 mm (0.0071/0.0173 in.)
TH18 .....	0.180/0.450 mm (0.0071/0.0177 in.)

**Piston Thrust Face O.D.<sup>2</sup>**

**TH16**

New .....	72.966/72.984 mm (2.8727/2.8734 in.)
Max. Wear Limit .....	72.839 mm (2.8677 in.)

**TH18**

New .....	74.966/74.984 mm (2.9514/2.9521 in.)
Max. Wear Limit .....	74.839 mm (2.9464 in.)

**Piston Thrust Face-to-Cylinder Bore<sup>2</sup> Running Clearance**

TH16 .....	0.022/0.065 mm (0.0009/0.0026 in.)
TH18 .....	0.041/0.084 mm (0.0016/0.0033 in.)

**Speed Control**

Speed Control Bracket Assembly Fastener Torque .....	9.9 N·m (88 in. lb.)
--	----------------------

**Stator**

Stator Mounting Screw Torque .....	4.0 N·m (35 in. lb.)
------------------------------------	----------------------

**Throttle/Choke Controls**

Governor Control Lever Fastener Torque .....	9.9 N·m (88 in. lb.)
--	----------------------

**Valve Cover**

Valve Cover Fastener Torque .....	5.6 N·m (50 in. lb.)
-----------------------------------	----------------------

**Valves**

Intake Valve Stem-to-Valve Guide Running Clearance .....	0.038/0.076 mm (0.0015/0.0030 in.)
--	------------------------------------

Exhaust Valve Stem-to-Valve Guide Running Clearance .....	0.050/0.088 mm (0.0020/0.0035 in.)
---	------------------------------------

**Intake Valve Guide I.D.**

New .....	6.038/6.058 mm (0.2377/0.2385 in.)
Max. Wear Limit .....	6.13 mm (0.2413 in.)

**Exhaust Valve Guide**

New .....	6.038/6.058 mm (0.2377/0.2385 in.)
Max. Wear Limit .....	6.19 mm (0.2437 in.)

**Valve Guide Reamer Size**

Standard .....	6.048 mm (0.2381 in.)
0.25 mm O.S. ....	6.298 mm (0.2480 in.)

Intake Valve Minimum Lift .....	7.50 mm (0.295 in.)
---------------------------------	---------------------

Exhaust Valve Minimum Lift .....	7.50 mm (0.295 in.)
----------------------------------	---------------------

Nominal Valve Seat Angle .....	45°
--------------------------------	-----

<sup>2</sup>Measure 6 mm (0.236 in.) above the bottom of the piston skirt at right angles to the piston pin.

# Section 1

## Safety and General Information






### Valves (Cont.)

#### Valve Lash






Intake .....	0.013/0.064 mm (0.0005/0.0025 in.)
Exhaust .....	0.076/0.127 mm (0.0030/0.0050 in.)

### General Torque Values

#### Metric Fastener Torque Recommendations for Standard Applications

Tightening Torque: N·m (in. lb.) + or - 10%						
	Property Class					Noncritical Fasteners Into Aluminum
Size						
<b>M 4</b>	1.2 (11)	1.7 (15)	2.9 (26)	4.1 (36)	5.0 (44)	2.0 (18)
<b>M 5</b>	2.5 (22)	3.2 (28)	5.8 (51)	8.1 (72)	9.7 (86)	4.0 (35)
<b>M 6</b>	4.3 (38)	5.7 (50)	9.9 (88)	14.0 (124)	16.5 (146)	6.8 (60)
<b>M 8</b>	10.5 (93)	13.6 (120)	24.4 (216)	33.9 (300)	40.7 (360)	17.0 (150)






Tightening Torque: N·m (ft. lb.) + or - 10%						
	Property Class					Noncritical Fasteners Into Aluminum
						
<b>M10</b>	21.7 (16)	27.1 (20)	47.5 (35)	66.4 (49)	81.4 (60)	33.9 (25)
<b>M12</b>	36.6 (27)	47.5 (35)	82.7 (61)	116.6 (86)	139.7 (103)	61.0 (45)
<b>M14</b>	58.3 (43)	76.4 (55)	131.5 (97)	184.4 (136)	219.7 (162)	94.9 (70)

### Torque Conversions

N·m = in. lb. x 0.113
N·m = ft. lb. x 1.356
in. lb. = N·m x 8.85
ft. lb. = N·m x 0.737

**Section 1**  
**Safety and General Information**

**1**

<b>Tightening Torque: N·m (in. lb.) + or - 20%</b>				
<b>Bolts, Screws, Nuts and Fasteners Assembled Into Cast Iron or Steel</b>				<b>Grade 2 or 5 Fasteners Into Aluminum</b>
	 <b>Grade 2</b>	 <b>Grade 5</b>	 <b>Grade 8</b>	 
<b>Size</b>				
<b>8-32</b>	2.3 (20)	2.8 (25)	-----	
<b>10-24</b>	3.6 (32)	4.5 (40)	-----	
<b>10-32</b>	3.6 (32)	4.5 (40)	-----	2.3 (20)
<b>1/4-20</b>	7.9 (70)	13.0 (115)	18.7 (165)	3.6 (32)
<b>1/4-28</b>	9.6 (85)	15.8 (140)	22.6 (200)	-----
<b>5/16-18</b>	17.0 (150)	28.3 (250)	39.6 (350)	7.9 (70)
<b>5/16-24</b>	18.7 (165)	30.5 (270)	-----	-----
<b>3/8-16</b>	29.4 (260)	-----	-----	17.0 (150)
<b>3/8-24</b>	33.9 (300)	-----	-----	-----
<b>Tightening Torque: N·m (ft. lb.) + or - 20%</b>				
<b>Size</b>				
<b>5/16-24</b>	-----	-----	40.7 (30)	-----
<b>3/8-16</b>	-----	47.5 (35)	67.8 (50)	-----
<b>3/8-24</b>	-----	54.2 (40)	81.4 (60)	-----
<b>7/16-14</b>	47.5 (35)	74.6 (55)	108.5 (80)	-----
<b>7/16-20</b>	61.0 (45)	101.7 (75)	142.4 (105)	-----
<b>1/2-13</b>	67.8 (50)	108.5 (80)	155.9 (115)	-----
<b>1/2-20</b>	94.9 (70)	142.4 (105)	223.7 (165)	-----
<b>9/16-12</b>	101.7 (75)	169.5 (125)	237.3 (175)	-----
<b>9/16-18</b>	135.6 (100)	223.7 (165)	311.9 (230)	-----
<b>5/8-11</b>	149.2 (110)	244.1 (180)	352.6 (260)	-----
<b>5/8-18</b>	189.8 (140)	311.9 (230)	447.5 (330)	-----
<b>3/4-10</b>	199.3 (150)	332.2 (245)	474.6 (350)	-----
<b>3/4-16</b>	271.2 (200)	440.7 (325)	637.3 (470)	-----

## Section 2

# Special Tools

These quality tools are designed to help you perform specific disassembly, repair, and reassembly procedures. By using tools designed for the job, you can service engines easier, faster, and safer! In addition, you'll increase your service capabilities and customer satisfaction by decreasing engine downtime.

Flywheel Strap Wrench .....	NU-10357
Flywheel Puller Kit .....	NU-3226
Water Manometer .....	25 761 02
Cylinder Leakdown Tester .....	25 761 05
Ignition System Tester .....	24 455 02
Camshaft Timing Tool Set .....	28 761 01
Starter Snap Ring Kit .....	25 761 18
Valve Blocking Tools and Engine Stand .....	28 761 02

Contact your Kohler Distributor for price and availability.

### Ignition System Tester

Use Kohler Part No. 24 455 02 to test the CD ignition modules on the OHC engines.

### Cylinder Leakdown Tester

Kohler Part No. 25 761 05 Cylinder Leakdown Tester is a valuable alternate to a compression test. By pressurizing the combustion chamber from an external air source, this tool can determine if valves or rings are leaking. Instructions for using this tester are found on page 3.4 of this manual.

### Special Tools You Can Make

#### Flywheel Holding Tool

Flywheel removal and reinstallation becomes a "snap" using a handy holding tool you can make out of a piece of an old "junk" flywheel ring gear as shown in Figure 2-1. Using an abrasive cut-off wheel, cut out a six tooth segment of the ring gear as shown. Grind off any burrs or sharp edges. The segment can be used in place of a strap wrench. Invert the segment and place it between the ignition bosses on crankcase so that the tool teeth engage the ring gear teeth on the flywheel. The bosses will "lock" the tool and flywheel in position for loosening, tightening or removing with a puller.

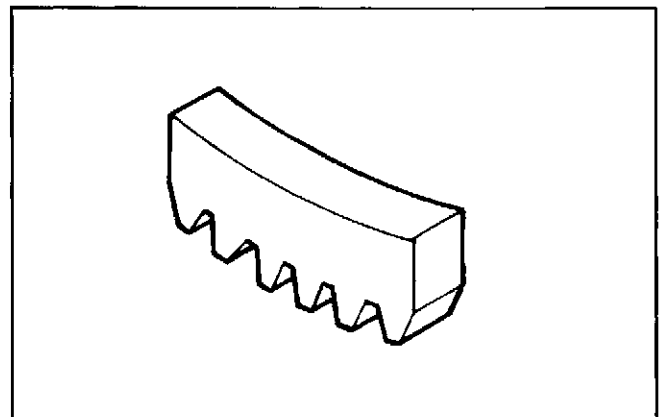


Figure 2-1. Flywheel Holding Tool.



## Section 2 Special Tools

### RTV Silicone Sealant

RTV silicone sealant is used as a gasket on the crankcase halves, breather cover gasket,\*\* and oil filter adapter. The chart below lists some of the approved sealants.

#### RTV Sealants

Vendor	Vendor No. and Description	
G.E.	RTV-102 White RTV-103 Black RTV-106 Red RTV-108 Clear	RTV-109 Gray RTV-154 Gray RTV-156 Red RTV-1473 Black
Loctite®**	593 Black 594 White 595 Clear	598 Black* 5900 Black
Permatex	6 Blue 6B Blue 6C Blue	6M Blue 66B Clear 66C Clear

\*NOTE: Loctite® No. 598 is available in a handy 10 cc size syringe type dispenser (with 2 disposable tips) under Kohler Part No. 25 597 04.

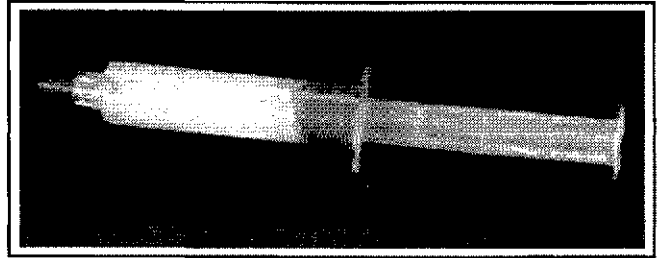


Figure 2-2. Loctite® No. 598 Syringe Dispenser.

NOTE: Always use **fresh** sealant. Using outdated sealant can result in leakage. Generally, the shelf life of an unopened dispenser is about 1 year while that of a used one is not more than 6 months.

\*\*NOTE: Two styles of breather cover gaskets have been used. One style has a sealant bead already on the surface and does not require any additional RTV.

## Section 3

# Troubleshooting

### Troubleshooting Guide

When troubles occur, be sure to check the simple causes which, at first, may seem too obvious to be considered. For example, a starting problem could be caused by an empty fuel tank.

Some common causes of engine troubles are listed below. Use these to locate the causing factors.

#### Engine Cranks But Will Not Start

1. Empty fuel tank.
2. Fuel shut-off valve closed.
3. Dirt or water in the fuel system.
4. Clogged fuel line.
5. Spark plug lead disconnected.
6. Key switch or kill switch in "off" position.
7. Faulty spark plugs.
8. Faulty ignition module.
9. Carburetor solenoid malfunction.

#### Engine Starts But Does Not Keep Running

1. Restricted fuel tank cap vent.
2. Dirt or water in the fuel system.
3. Faulty choke or throttle controls.
4. Loose wires or connections that short the kill terminal of ignition module to ground.
5. Faulty carburetor.

#### Engine Starts Hard

1. PTO drive is engaged.
2. Dirt or water in the fuel system.
3. Clogged fuel line.
4. Loose or faulty wires or connections.
5. Faulty choke or throttle controls.
6. Faulty spark plugs.
7. Low compression.
8. Weak spark.

#### Engine Will Not Crank.

1. PTO drive is engaged.
2. Battery is discharged.
3. Safety interlock switch is engaged.
4. Loose or faulty wires or connections.
5. Faulty key switch or ignition switch.
6. Faulty electric starter or solenoid.
7. Seized internal engine components.

#### Engine Runs But Misses

1. Dirt or water in the fuel system.
2. Spark plug lead disconnected.
3. Loose wires or connections.
4. Engine overheated.
5. Faulty ignition module.
6. Faulty spark plugs.

#### Engine Will Not Idle

1. Restricted fuel tank cap vent.
2. Dirt or water in the fuel system.
3. Faulty spark plugs.
4. Idle speed adjusting screw improperly set.
5. Low compression.
6. Stale fuel and/or gum in carburetor.

#### Engine Overheats

1. Air intake or grass screen, cooling fins, or cooling shrouds clogged.
2. Excessive engine load.
3. Low crankcase oil level.
4. High crankcase oil level.
5. Faulty carburetor.

#### Engine Knocks

1. Excessive engine load.
2. Low crankcase oil level.
3. Old or improper fuel.
4. Internal wear or damage.

## Section 3

### Troubleshooting

---

#### Engine Loses Power

1. Low crankcase oil level.
2. High crankcase oil level.
3. Dirty air cleaner element.
4. Dirt or water in the fuel system.
5. Excessive engine load.
6. Engine overheated.
7. Faulty spark plugs.
8. Low compression.
9. Exhaust restriction.

#### Engine Uses Excessive Amount Of Oil

1. Incorrect oil viscosity/type.
2. Clogged or improperly assembled breather.
3. Worn or broken piston rings.
4. Worn cylinder bore.
5. Worn valve stems or valve guides.
6. Crankcase overfilled.

#### Oil Leaks From Oil Seals, Gaskets

1. Crankcase breather is clogged or inoperative.
2. Loose or improperly torqued fasteners.
3. Piston blowby or leaky valves.
4. Restricted exhaust.

#### External Engine Inspection

Before cleaning or disassembling the engine, make a thorough inspection of its external appearance and condition. This inspection can give clues to what might be found inside the engine (and the cause) when it is disassembled.

- Check for buildup of dirt and debris on the crankcase, cooling fins, grass screen and other external surfaces. Dirt or debris on these areas are causes of overheating.
- Check for obvious fuel and oil leaks, and damaged components. Excessive oil leakage can indicate a clogged or improperly assembled breather, worn or damaged seals and gaskets, or loose or improperly torqued fasteners.
- Check the air cleaner cover and base for damage or indications of improper fit and seal.

- Check the air cleaner element. Look for holes, tears, cracked or damaged sealing surfaces, or other damage that could allow unfiltered air into the engine. Also note if the element is dirty or clogged. These could indicate that the engine has been underserviced.

- Check the carburetor throat for dirt. Dirt in the throat is further indication that the air cleaner is not functioning properly.

- Check the oil level. Note if the oil level is within the operating range on the dipstick, or if it is low or overfilled.

- Check the condition of the oil. Drain the oil into a container - the oil should flow freely. Check for metal chips and other foreign particles.

Sludge is a natural by-product of combustion; a small accumulation is normal. Excessive sludge formation could indicate overrich carburetion, weak ignition, overextended oil change interval or wrong weight or type of oil was used, to name a few.

**NOTE:** It is good practice to drain oil at a location away from the workbench. Be sure to allow ample time for complete drainage.

#### Cleaning the Engine

After inspecting the external condition of the engine, clean the engine thoroughly before disassembling it. Also clean individual components as the engine is disassembled. Only clean parts can be accurately inspected and gauged for wear or damage. There are many commercially available cleaners that will quickly remove grease, oil, and grime from engine parts. When such a cleaner is used, *follow the manufacturer's instructions and safety precautions carefully.*

Make sure all traces of the cleaner are removed before the engine is reassembled and placed into operation. Even small amounts of these cleaners can quickly break down the lubricating properties of engine oil.

**Basic Engine Tests**

**Crankcase Vacuum Test**

A partial vacuum should be present in the crankcase when the engine is operating at normal temperatures. Pressure in the crankcase (normally caused by a clogged or improperly assembled breather) can cause oil to be forced out at oil seals, gaskets, or other available spots.

Crankcase vacuum is best measured with a water manometer. Kohler Part No. 25 761 02 is recommended. Complete instructions are provided in kit.

Test the crankcase vacuum with manometer as follows:

1. Insert the stopper/hose into the oil fill hole. Leave the other tube of manometer open to atmosphere.

Make sure the shut-off clamp is closed.

2. Start the engine and run at no-load high idle speed (3200 to 3750 RPM).

3. Open the clamp and note the water level in the tube.

The level in the engine side should be a minimum of **30 cm (12 in.)** above the level in the open side.

If the level in the engine side is the same as the open side (no vacuum), or the level in the engine side is lower than the level in the open side (pressure), check for the conditions in the table below.

4. Close the shut-off clamp **before** stopping the engine.



**No Crankcase Vacuum/Pressure in Crankcase**

Possible Cause	Solution
1. Crankcase breather clogged or inoperative.	1. Disassemble breather, clean parts thoroughly, reassemble, and recheck pressure.
2. Seals and/or gaskets leaking. Loose or improperly torqued fasteners.	2. Replace all worn or damaged seals and gaskets. Make sure all fasteners are tightened securely. Use appropriate torque values and sequences when necessary.
3. Piston blowby or leaky valves. (Confirm by inspecting components.	3. Replace piston and/or rings. Recondition/replace valves. Recondition valve guides. See Section 10.
4. Restricted exhaust.	4. Repair/replace restricted muffler/exhaust system.

**Compression Test**

Some of these engines are equipped with an automatic compression release (ACR) mechanism. Because of the ACR mechanism, it is difficult to obtain an accurate compression reading. As an alternate, use the leakdown test described on the next page.

## Section 3

### Troubleshooting

---

#### Cylinder Leakdown Test

A cylinder leakdown test can be a valuable alternative to a compression test. By pressurizing the combustion chamber from an external air source, you can determine if the valves or rings are leaking, and how badly.

Kohler Part No. 25 761 05 is a relatively simple, inexpensive leakdown tester for small engines. The tester includes a quick disconnect for attaching the adapter hose, and a holding tool.

#### Leakdown Test Instructions

1. Run engine for 3-5 minutes to warm it up.
2. Remove spark plug(s) and air filter from engine.
3. Rotate crankshaft until piston (of cylinder being tested) is at top dead center of compression stroke. You will need to hold the engine in this position while testing. The holding tool supplied with the tester can be used if the PTO end of the crankshaft is accessible. Slide the holding tool onto the crankshaft and adjust the set screw to fit in the key slot. Install a 3/8" breaker bar into the square hole of the holding tool, so it is perpendicular to both the holding tool and crankshaft PTO. If the flywheel end is more accessible, you can use a breaker bar and socket on the flywheel nut/screw to hold it in position. You may need an assistant to hold the breaker bar during testing. If the engine is mounted in a piece of equipment, you may be able to hold it by clamping or wedging a driven component. Just be certain that the engine cannot rotate off of TDC in either direction.
4. Install the adapter into the spark plug hole, but do not attach it to the tester at this time.
5. Connect an air source of at least 50 psi to the tester.
6. Turn the regulator knob in the increase (clockwise) direction until the gauge needle is in the yellow "set" area at the low end of the scale.
7. Connect tester quick-disconnect to the adapter hose while firmly holding the engine at TDC. Note the gauge reading and listen for escaping air at the carburetor intake, exhaust outlet, and crankcase breather.
8. Check your test results against the table below:

#### Leakdown Test Results

Air escaping from crankcase breather .....	Defective rings or worn cylinder walls.
Air escaping from exhaust system .....	Defective exhaust valve.
Air escaping from carburetor .....	Defective intake valve.
Gauge reading below 25% leakage .....	Piston rings and cylinder in good condition.
Gauge reading 25% - 50% leakage .....	Engine is still usable, but there is some wear present. Customer should start planning for overhaul or replacement.
Gauge reading above 50% leakage .....	Rings and/or cylinder have considerable wear. Engine should be reconditioned or replaced.

## Section 4

# Air Cleaner and Air Intake System

### Air Cleaners

#### General

These engines are equipped with a replaceable, high-density paper air cleaner element. Most are also equipped with an oiled-foam precleaner which surrounds the paper element.

Two different types are used. The standard type air cleaner is shown in Figure 4-1, while the top tank type air cleaner is shown in Figure 4-2. Internal components vary, however the service recommendations are the same.

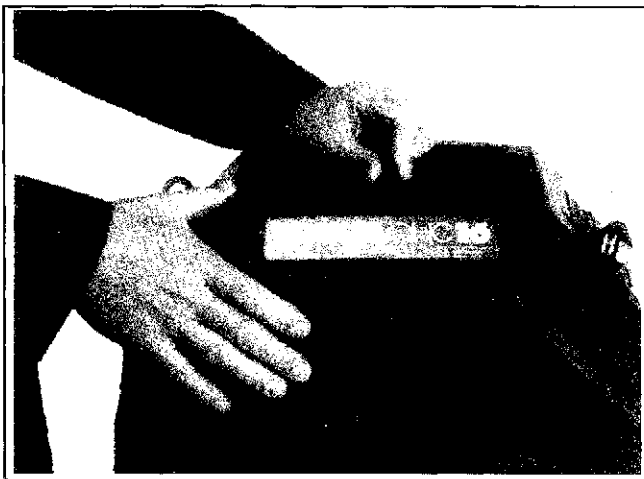


Figure 4-1. Standard Air Cleaner.

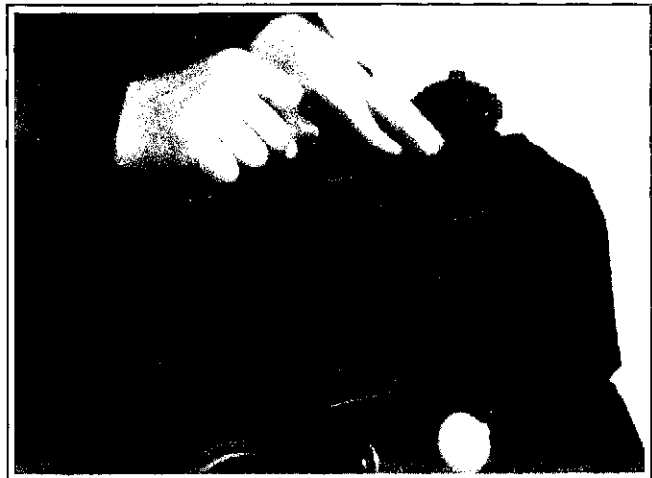


Figure 4-2. Top Tank Air Cleaner.

#### Service

Check the air cleaner **daily or before starting the engine**. Check for and correct heavy buildup of dirt and debris along with loose or damaged components.

**NOTE:** Operating the engine with loose or damaged air cleaner components could allow unfiltered air into the engine causing premature wear and failure.

#### Precleaner Service

If so equipped, wash and reoil the precleaner every **25 hours** of operation (more often under extremely dusty or dirty conditions).

To service the precleaner perform the following steps:

1. Loosen the cover retaining knob and remove the cover.
2. Remove the foam precleaner from the paper air cleaner element.

## Section 4

### Air Cleaner and Air Intake System

---

3. Wash the precleaner in warm water with detergent. Rinse the precleaner thoroughly until all traces of detergent are eliminated. Squeeze out excess water (do not wring). Allow the precleaner to air dry.
4. Saturate the precleaner with new engine oil. Squeeze out all excess oil.
5. Reinstall the precleaner over the paper air cleaner element.
6. Reinstall the air cleaner cover. Secure cover with the cover retaining knob.

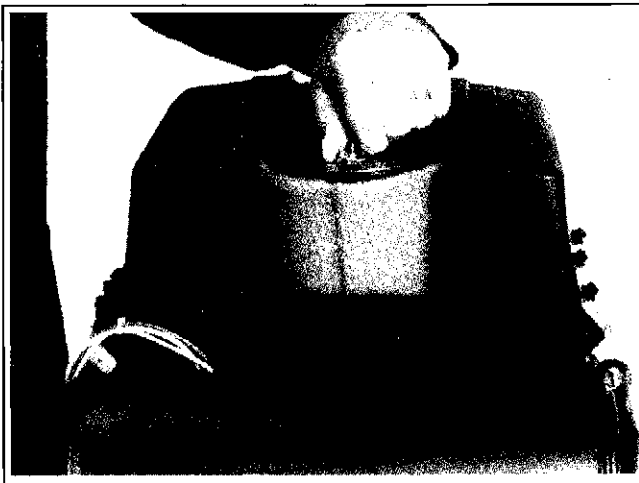


Figure 4-3. Top Tank Air Cleaner with Cover Removed.

#### Paper Element Service

Every **100 hours** of operation (more often under extremely dusty or dirty conditions), replace the paper element. Follow these steps:

1. Loosen the cover retaining knob and remove the cover.
2. Remove the wing nut(s), element cover, and air cleaner element.
3. Remove the precleaner (if so equipped) from the paper element. Service the precleaner.
4. **Do not wash the paper element or use pressurized air**, as this will damage the element. Replace a dirty, bent, or damaged element with a genuine Kohler element. Handle new elements carefully; do not use if the sealing surfaces are bent or damaged.
5. Reinstall the paper element, precleaner, element cover, and wing nut(s).
6. Reinstall the air cleaner cover and secure cover with the retaining knob.

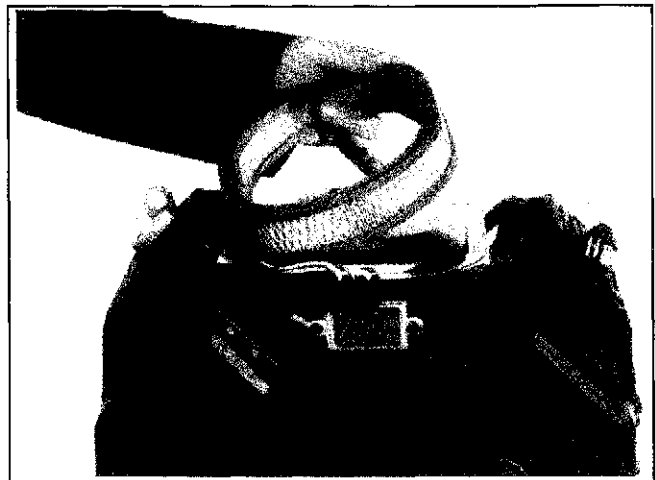


Figure 4-4. Removing Element on Standard Type.

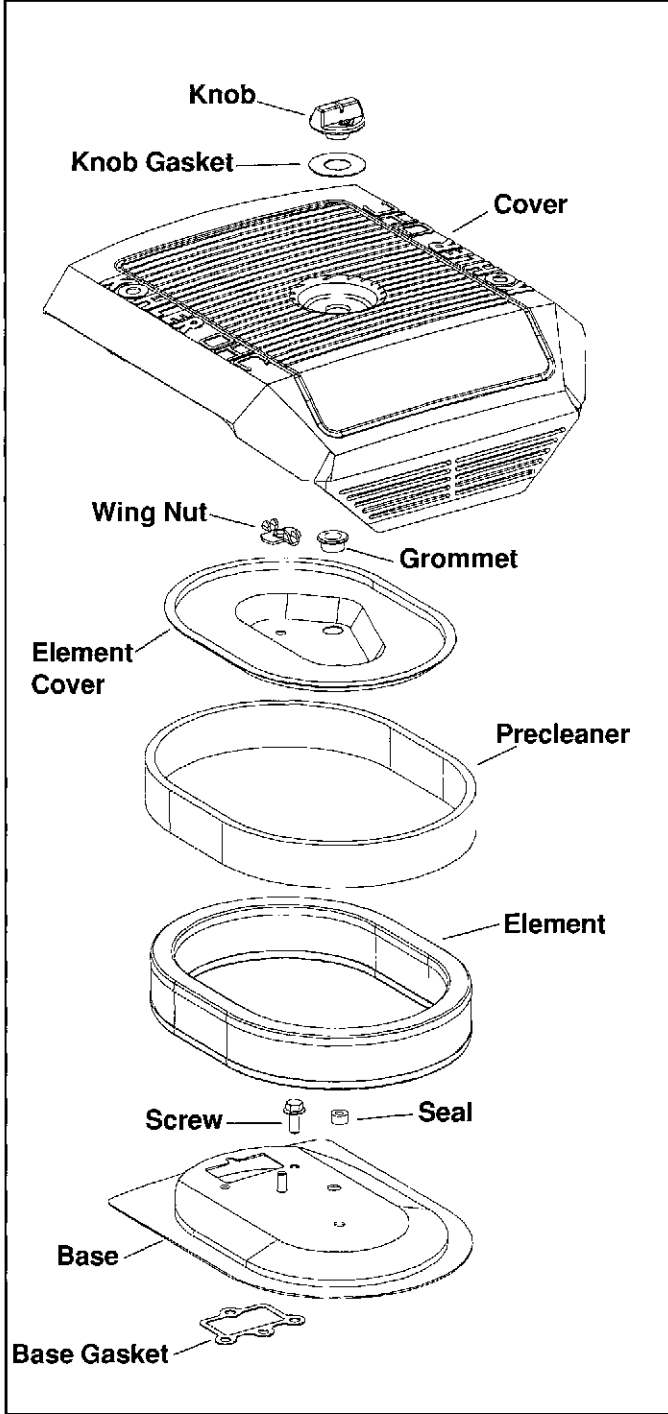


Figure 4-5. Standard Air Cleaner System Components.

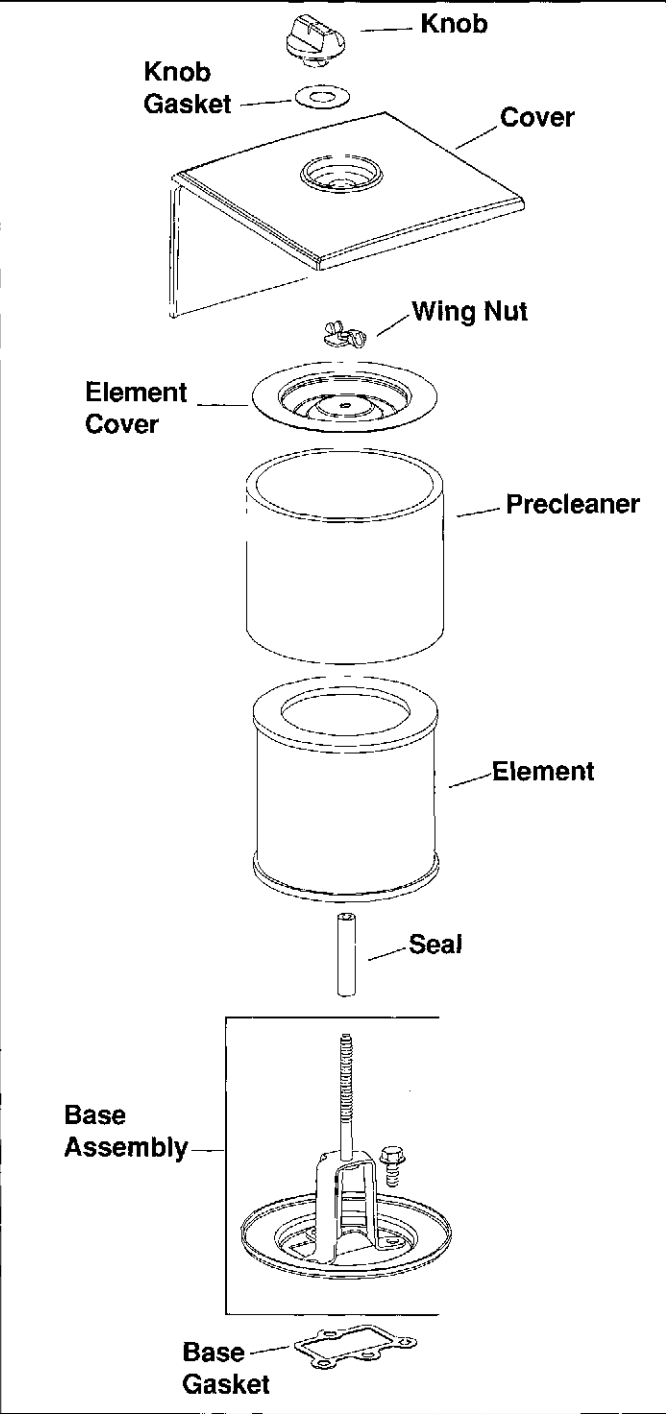


Figure 4-6. Top Tank Air Cleaner System Components.



## Section 4

### Air Cleaner and Air Intake System

#### Air Cleaner Components

Whenever the air cleaner cover is removed, or the paper element or precleaner are serviced, check the following:

**Air Cleaner Element Cover, Grommet, and Seal –** Make sure element cover is not bent or damaged. Make sure the wing nut, grommet, and seals are in place to ensure the element is sealed against leakage. Be sure the grommet aligns with the hole in the base. If the element cover is installed backward, the hole in the base will not be sealed.

**Air Cleaner Base –** Make sure the base is secured tightly to carburetor elbow and not cracked or damaged.

NOTE: Damaged, worn, or loose air cleaner components can allow unfiltered air into the engine causing premature wear and failure. Tighten or replace all loose or damaged components.

#### Complete Disassembly and Reassembly

If the base plate has to be removed, proceed as follows:

1. Remove air cleaner components from the base as described under "Paper Element Service" (see page 4.2).
2. Remove the hex. flange screws securing the bracket (top tank version) and base (Figure 4-7).
3. Remove the base and gasket.
4. Reverse procedure to reassemble components. Tighten screws to **9.9 N·m (88 in. lb.)** torque.

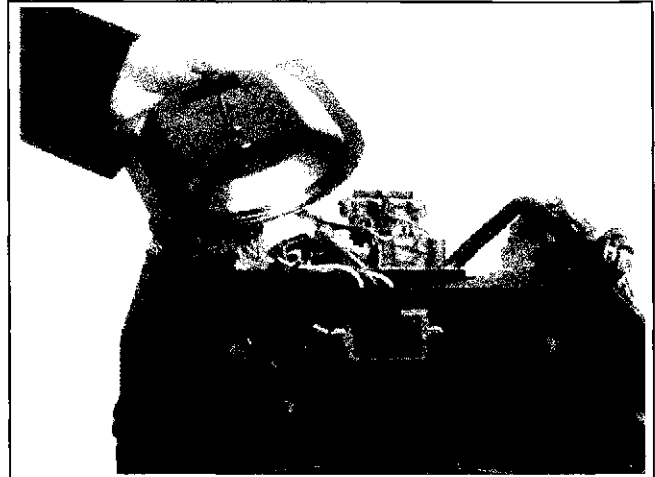


Figure 4-7. Removing Base on Standard Type Air Cleaner.

#### Air Intake/Cooling System

To ensure proper cooling, make sure the grass screen, cooling fins, and other external surfaces of the engine are kept clean **at all times**.

Every **100 hours** of operation (more often under extremely dusty or dirty conditions), remove the blower housing and other cooling shrouds.\* Clean the cooling fins and external surfaces as necessary. Make sure the cooling shrouds are reinstalled.

\*Cleanout kit 24 755 90 can be used for inspection and cleanout of the cooling fins without removing the blower housing or shrouds.

NOTE: Operating the engine with a blocked grass screen, dirty or plugged cooling fins, and/or cooling shrouds removed, will cause engine damage due to overheating.

# Section 5

## Fuel System and Governor

### Description

#### **WARNING: Explosive Fuel!**

*Gasoline is extremely flammable and its vapors can explode if ignited. Store gasoline only in approved containers, in well ventilated, unoccupied buildings, away from sparks or flames. Do not fill the fuel tank while the engine is hot or running, since spilled fuel could ignite if it comes in contact with hot parts or sparks from ignition. Do not start the engine near spilled fuel. Never use gasoline as a cleaning agent.*

#### Fuel System Components

The typical fuel system and related components include the following:

- Fuel Tank
- Fuel Lines
- In-Line Fuel Filter
- Fuel Pump
- Carburetor

#### Operation

The fuel from the tank is moved through the in-line filter and fuel lines by the fuel pump. Fuel then enters the carburetor float bowl and is moved into the carburetor body. There, the fuel is mixed with air. This fuel-air mixture is then burned in the engine combustion chambers.

#### Fuel Recommendations

##### General Recommendations

Purchase gasoline in small quantities and store in clean, approved containers. A container with a capacity of 2 gallons or less with a pouring spout is recommended. Such a container is easier to handle and helps eliminate spillage during refueling.

- Do not use gasoline left over from the previous season to minimize gum deposits in your fuel system and to ensure easy starting.
- Do not add oil to the gasoline.
- Do not overfill the fuel tank. Leave room for the fuel to expand.

#### Fuel Type

For best results, use only clean, fresh, unleaded gasoline with a pump sticker octane rating of 87 or higher. In countries using the Research fuel rating method, it should be 90 octane minimum.

Unleaded gasoline is recommended, as it leaves less combustion chamber deposits.

#### Gasoline/Alcohol blends

Gasohol (up to 10% ethyl alcohol, 90% unleaded gasoline by volume) is approved as a fuel for Kohler engines. Other gasoline/alcohol blends are not approved.

#### Gasoline/Ether blends

Methyl Tertiary Butyl Ether (MTBE) and unleaded gasoline blends (up to a maximum of 15% MTBE by volume) are approved as a fuel for Kohler engines. Other gasoline/ether blends are not approved.

#### Fuel Filter

Most engines are equipped with an in-line filter. Periodically inspect the filter and replace when dirty with a genuine Kohler filter.

## Section 5

### Fuel System and Governor

---

#### Fuel System Tests

When the engine starts hard, or turns over but will not start, it is possible that the problem is in the fuel system. To find out if the fuel system is causing the problem, perform the following tests.

#### Troubleshooting — Fuel System Related Causes

Test	Conclusion
1. Check the following: <ol style="list-style-type: none"> <li>a. Make sure the fuel tank contains clean, fresh, proper fuel.</li> <li>b. Make sure the vent in fuel tank cap is open.</li> <li>c. Make sure the fuel valve is open.</li> </ol>	
2. Check for fuel in the combustion chamber. <ol style="list-style-type: none"> <li>a. Disconnect and ground spark plug leads.</li> <li>b. Close the choke on the carburetor.</li> <li>c. Crank the engine several times.</li> <li>d. Remove the spark plug and check for fuel at the tip.</li> </ol>	2. If there <b>is</b> fuel at the tip of the spark plug, fuel is reaching the combustion chamber.  If there is <b>no</b> fuel at the tip of the spark plug, check for fuel flow from the fuel tank (Test 3).
3. Check for fuel flow from the tank to the fuel pump. <ol style="list-style-type: none"> <li>a. Remove the fuel line from the inlet fitting of fuel pump.</li> <li>b. Hold the line below the bottom of the tank. Open the shut-off valve (if so equipped) and observe flow.</li> </ol>	3. If fuel <b>does</b> flow from the line, check for faulty fuel pump (Test 4).  If fuel <b>does not</b> flow from the line, check for clogged fuel tank vent, fuel pick-up screen, in-line filter, shut-off valve, and fuel lines.
4. Check the operation of fuel pump. <ol style="list-style-type: none"> <li>a. Remove the fuel line from the inlet fitting of carburetor.</li> <li>b. Crank the engine several times and observe flow.</li> </ol>	4. If fuel <b>does</b> flow from the line, check for faulty carburetor. (Refer to the "Carburetor" portions of this section.)  If fuel <b>does not</b> flow from the line, check for clogged fuel line. If the fuel line is unobstructed, the fuel pump is faulty and must be replaced.

## Fuel Pump

### General

Most engines are equipped with a mechanical fuel pump. The pumping action is created by a lobe on the #1 side camshaft. The pumping action causes the diaphragm on the inside of the pump to pull fuel in on its downward stroke and to push it into the carburetor on its upward stroke. Two check valves prevent fuel from going backward through the pump.

### Performance

Fuel pump outlet pressure should not exceed 13.79 kPa (2 psi) to avoid overriding the float system in the carburetor.

### Replacing the Fuel Pump

Replacement valve cover/fuel pumps are available through your source of supply. To replace the valve cover/fuel pump assembly, follow these steps:

1. Disconnect the fuel lines from the inlet and outlet fittings.

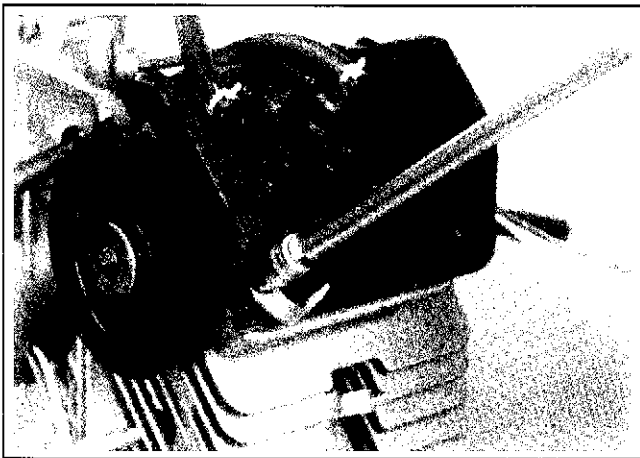


Figure 5-1. Removing #1 Side Valve Cover/Fuel Pump Assembly.

2. Remove the four hex. flange screws and valve cover/fuel pump.
3. Install a new valve cover/fuel pump using the hex. flange screws.
4. Tighten the hex. flange screws to **5.6 N·m (50 in. lb.)**.
5. Connect the fuel lines to the inlet and outlet fittings.

## Carburetor

### General

Engines in this series are equipped with fixed jet carburetors. Some applications utilize a fuel shut-off solenoid which is installed in place of the fuel bowl retaining screw. All carburetors feature the self-relieving choke components shown in the exploded view on page 5.9. These carburetors include three main circuits which function as follows.

**Float Circuit:** Fuel level in the bowl is maintained by the float and fuel inlet needle. The buoyant force of the float stops fuel flow when the engine is at rest. When fuel is being consumed, the float will drop and fuel pressure will push the inlet needle away from the seat, allowing more fuel to enter the bowl. When demand ceases, the buoyant force of the float will again overcome the fuel pressure and stop the flow.

**Slow Circuit** (See Figure 5-2): At low speeds the engine operates only on the slow circuit. As a metered amount of air is drawn through the slow air bleed jet, fuel is drawn through the main jet and further metered through the slow jet. Air and fuel are mixed in the body of the slow jet and exit to the transfer port. From the transfer port this air fuel mixture is delivered to the idle progression chamber. From the idle progression chamber the air fuel mixture is metered through the idle port passage. At low idle when the vacuum signal is weak, the air fuel mixture is controlled by the setting of the non-accessible idle adjust screw. This mixture is then mixed with the main body of air and delivered to the engine. As the throttle plate opening increases, greater amounts of air fuel mixture are drawn in through the fixed and metered idle progression holes. As the throttle plate opens further the vacuum signal becomes great enough so the main circuit begins to work.

## Section 5 Fuel System and Governor

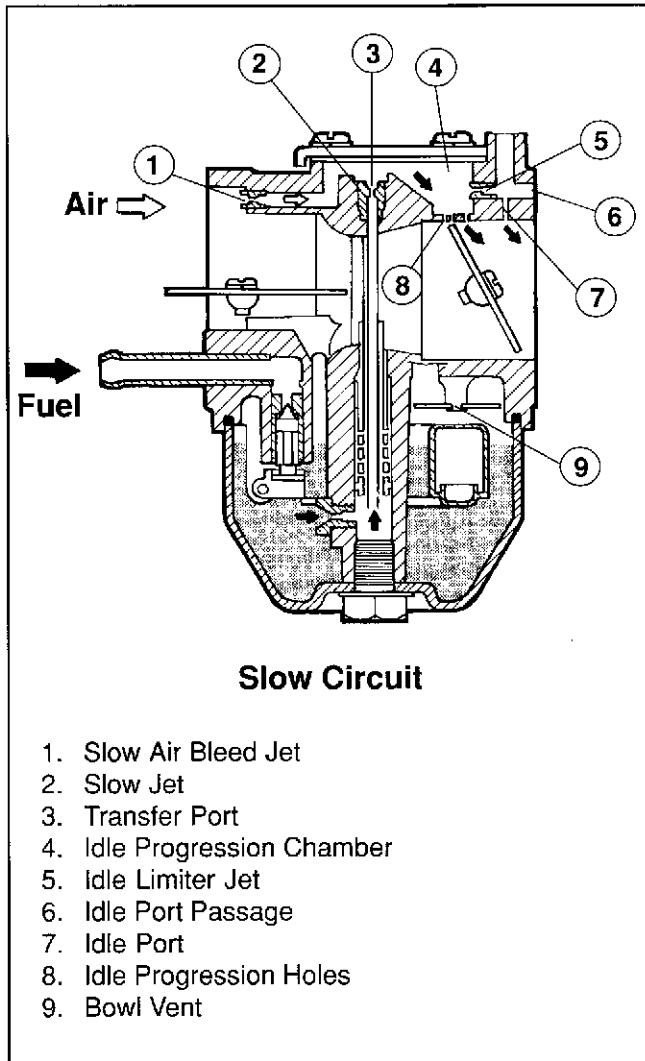


Figure 5-2. Slow Circuit.

**Main Circuit (Figure 5-3):** At high loads, the engine operates mostly on the main circuit. As a metered amount of air is drawn through the main air bleed jet, fuel is drawn through the main jet. The air and fuel are mixed in the main nozzle and then enter the main body of air flow, where further mixing of the fuel and air takes place. This mixture is then delivered to the combustion chamber. The carburetor has a fixed main circuit. There is no adjustment feature present.

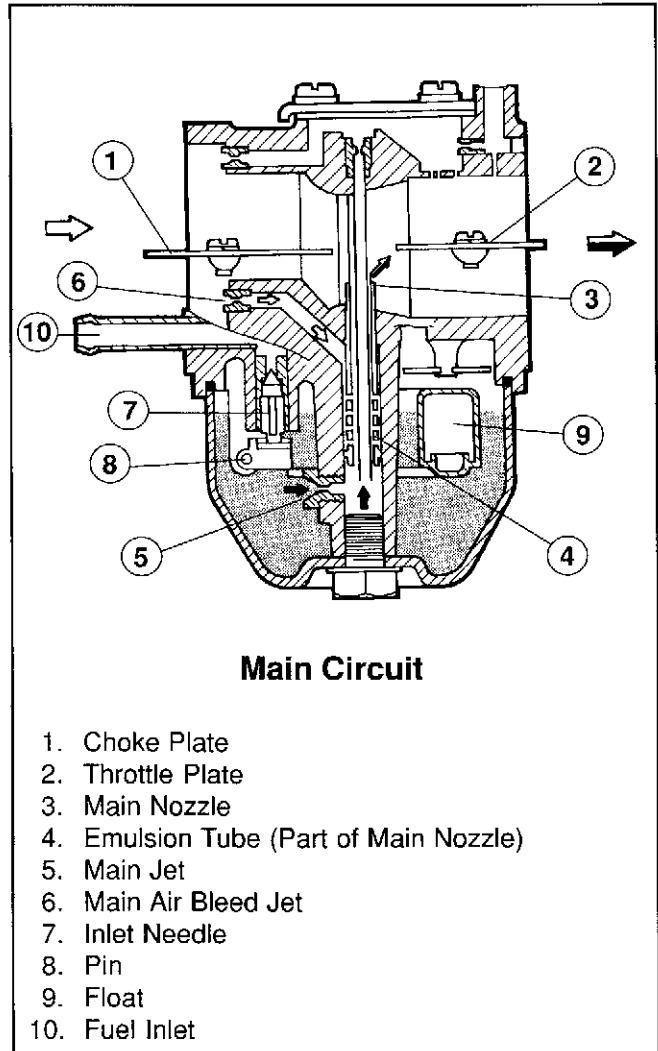


Figure 5-3. Main Circuit.

**Troubleshooting - Carburetor Related Causes**

Condition	Possible Cause/Probable Remedy
1. Engine starts hard, runs roughly, or stalls at idle speed.	1. Low idle speed improperly adjusted. Adjust the low idle speed screw.
2. Engine runs rich (indicated by black, sooty exhaust smoke, misfiring, loss of speed and power, governor hunting, or excessive throttle opening).	2a. Clogged air cleaner. Clean or replace. b. Choke partially closed during operation. Check the choke lever/linkage to ensure choke is operating properly. c. Float level too high. Separate fuel bowl from carburetor body. Free (if stuck), or replace float. d. Dirt under the fuel inlet needle. Remove needle; clean needle and seat and blow with compressed air. e. Bowl vent or air bleeds plugged. Clean vent, ports, and air bleeds. Blow out all passages with compressed air. f. Leaky, cracked, or damaged float. Submerge float to check for leaks.
3. Engine runs lean (indicated by misfiring, loss of speed and power, governor hunting, or excessive throttle opening).	3a. Float level too low. Separate fuel bowl from carburetor body. Free (if stuck) or replace float. b. Idle holes plugged; dirt in fuel delivery channels. Clean main fuel jet and all passages; blow out with compressed air.
4. Fuel leaks from carburetor.	4a. Float stuck. See Remedy 2c. b. Dirt under fuel inlet needle. See Remedy 2d. c. Bowl vents plugged. Blow out with compressed air. d. Carburetor bowl gasket leaks. Replace gasket.

5

**Troubleshooting Checklist**

When the engine starts hard, runs roughly, or stalls at low idle speed, check the following areas before adjusting or disassembling the carburetor.

- Make sure the fuel tank is filled with clean, fresh gasoline.
- Make sure the fuel tank cap vent is not blocked and that it is operating properly.
- Make sure fuel is reaching the carburetor. This includes checking the fuel shut-off valve, fuel tank filter screen, in-line fuel filter, fuel lines, and fuel pump for restrictions or faulty components as necessary.

- Make sure the air cleaner base and carburetor are securely fastened to the engine using gaskets in good condition.
- Make sure the air cleaner element is clean and all air cleaner components are fastened securely.
- Make sure the ignition system, governor system, exhaust system, and throttle and choke controls are operating properly.

If the engine is still hard to start, runs roughly, or stalls at low idle speed, it may be necessary to service the carburetor.

## Section 5

### Fuel System and Governor

#### Fuel Shut-off Solenoid

Some carburetors are equipped with an optional fuel shut-off solenoid. The solenoid is installed in place of the bowl retaining screw. The solenoid has a spring-loaded pin that retracts when 12 volt current is applied to the lead. The pin blocks the main fuel jet and prevents fuel from entering the carburetor when it is extended.

Below is a simple test made with the engine off that can determine if the solenoid is functioning properly:

1. Shut off the fuel and remove the solenoid from the carburetor. When the solenoid is loosened and removed, gas will leak out of the carburetor. Have a container ready to catch the fuel.
2. Attach a wire between the solenoid ground lead terminal and a battery ground with alligator clips.

#### **⚠ CAUTION**

*Do this test away from any fuel/vapors to prevent an accident.*

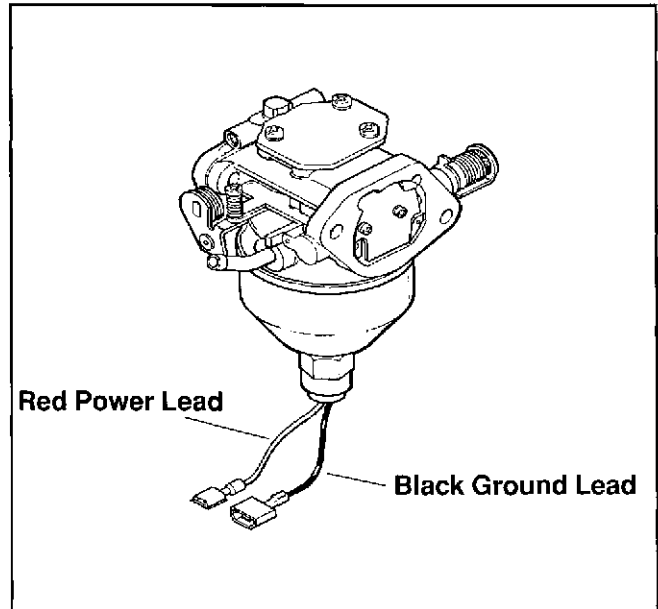
3. Insert a bare 1/4" male spade terminal into the terminal end of the power lead. Touch the exposed terminal to the positive (+) post of the battery.
4. If pin retracts, the solenoid is good.

#### Adjustments

##### General

The carburetor is designed to deliver the correct fuel-to-air mixture to the engine under all operating conditions. Fuel mixture settings are set at the factory and are not adjustable.

NOTE: Carburetor speed adjustment should be made only after the engine has warmed up.



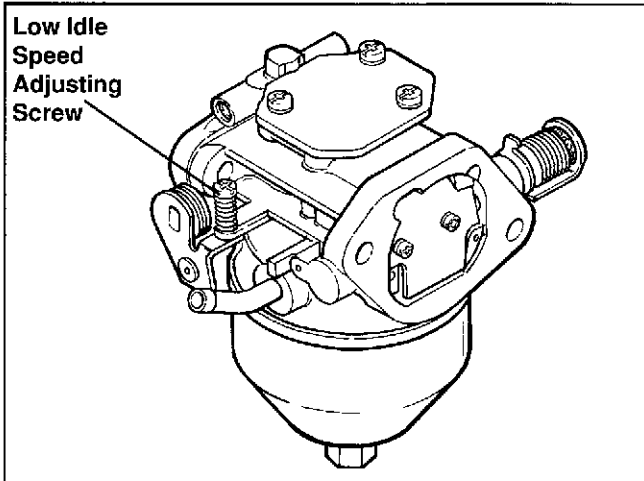
**Figure 5-4. Fuel Shut-off Solenoid Equipped Carburetor.**

##### Low Idle Speed Adjusting Screw

To adjust the carburetor idle speed, see Figure 5-5 and follow these steps:

1. Start the engine and run at half throttle for 5 to 10 minutes to warm up. The engine must be warm before making final settings. Check that the throttle and choke plates can fully open.

NOTE: The carburetor has a self-relieving choke. Choke plate and shaft assembly is spring loaded. Check to make sure plate moves freely and is not binding and affecting idle fuel delivery.



**Figure 5-5. Carburetor Adjustment**

2. Place the throttle control into the “idle” or “slow” position. Turn the low idle speed adjusting screw **in** or **out** to obtain a low idle speed of **1200 RPM** ( $\pm 75$  RPM). Check the speed using a tachometer.

\*NOTE: The actual low idle speed depends on the application. Refer to the equipment manufacturer’s recommendations. The low idle speed for basic engines is 1200 RPM ( $\pm 75$  RPM).

### Float Replacement

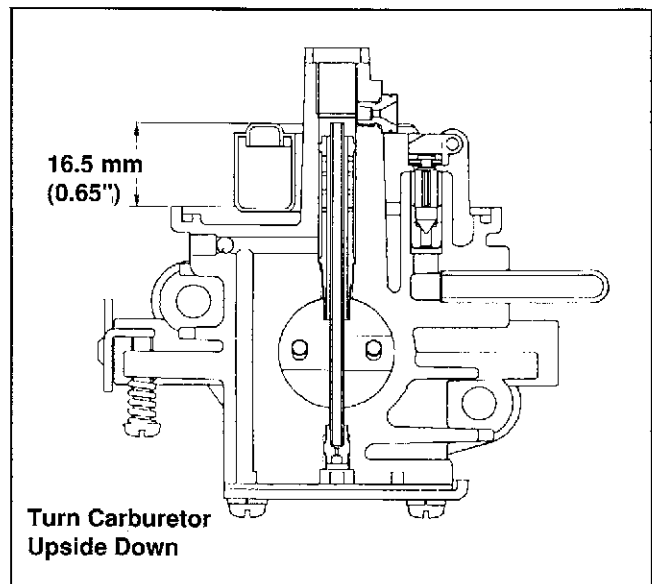
If symptoms described in the carburetor troubleshooting guide indicate float level problems, remove the carburetor from the engine to check and/or replace the float. Use Float Kit to replace float, pin and inlet needle or valve.

#### Float Kit Contains:

Qty.	Description
1	Float
1	Valve, float (inlet needle)
1	Pin, float
1	Gasket, carburetor
1	Gasket, air cleaner base

1. Remove the air cleaner and air intake components from the carburetor as described in Section 4.
2. Disconnect the fuel inlet line from the carburetor.
3. Disconnect governor/throttle linkage from the carburetor.

4. Disconnect lead wires from fuel shut-off solenoid equipped carburetor.
5. Slide the carburetor off the retaining studs. Remove the fuel bowl retaining nut or fuel shut-off solenoid and drain fuel from the bowl into a safe container. Remove the bowl from the carburetor body.
6. Turn the carburetor body upside down and check level of the float as shown in Figure 5-6. With the float needle valve fully seated, 16.5 mm (.65”) should be measured from the body to float as indicated. Don’t attempt to adjust by bending the tab -- replace float with kit if level is wrong.



**Figure 5-6. Proper Float Level.**

7. Pull the float hinge pin and remove the float with float needle valve attached to inspect these parts and needle seat. If dirty, blow out with compressed air. Replace float components as needed with kit.
8. Use new bowl gaskets, reinstall bowl, tighten bowl retaining screw or solenoid if used to **5.1/6.2 N·m (45/55 in. lb.)**.
9. Reinstall carburetor on engine, reconnect fuel line, control linkages and air intake components. Retest operation.



## Section 5 Fuel System and Governor

### Disassembly

Disassemble carburetor as follows after removal from engine. See Figure 5-7.

1. Remove the fuel bowl retaining screw or solenoid assembly then remove bowl and bowl gasket.
2. Pull the float hinge pin and remove the float with inlet needle attached.
3. Remove the vent plug from the column on solenoid equipped carburetors.
4. Remove the setscrews holding the throttle plate to the throttle shaft and pull the throttle shaft from carburetor body.
5. Remove the setscrews securing the choke plate to the choke shaft assembly and pull the choke shaft assembly out of the carburetor body. Disassemble self-relieving parts from shaft as needed.
6. Remove the three screws holding the passage cover to the body and remove the cover gasket.
7. Remove the slow speed adjusting needle and spring. Except for the slow jet nozzle, main jet, and emulsion tubes, which are considered non-serviceable, the carburetor is now completely disassembled and ready for thorough inspection and cleaning.

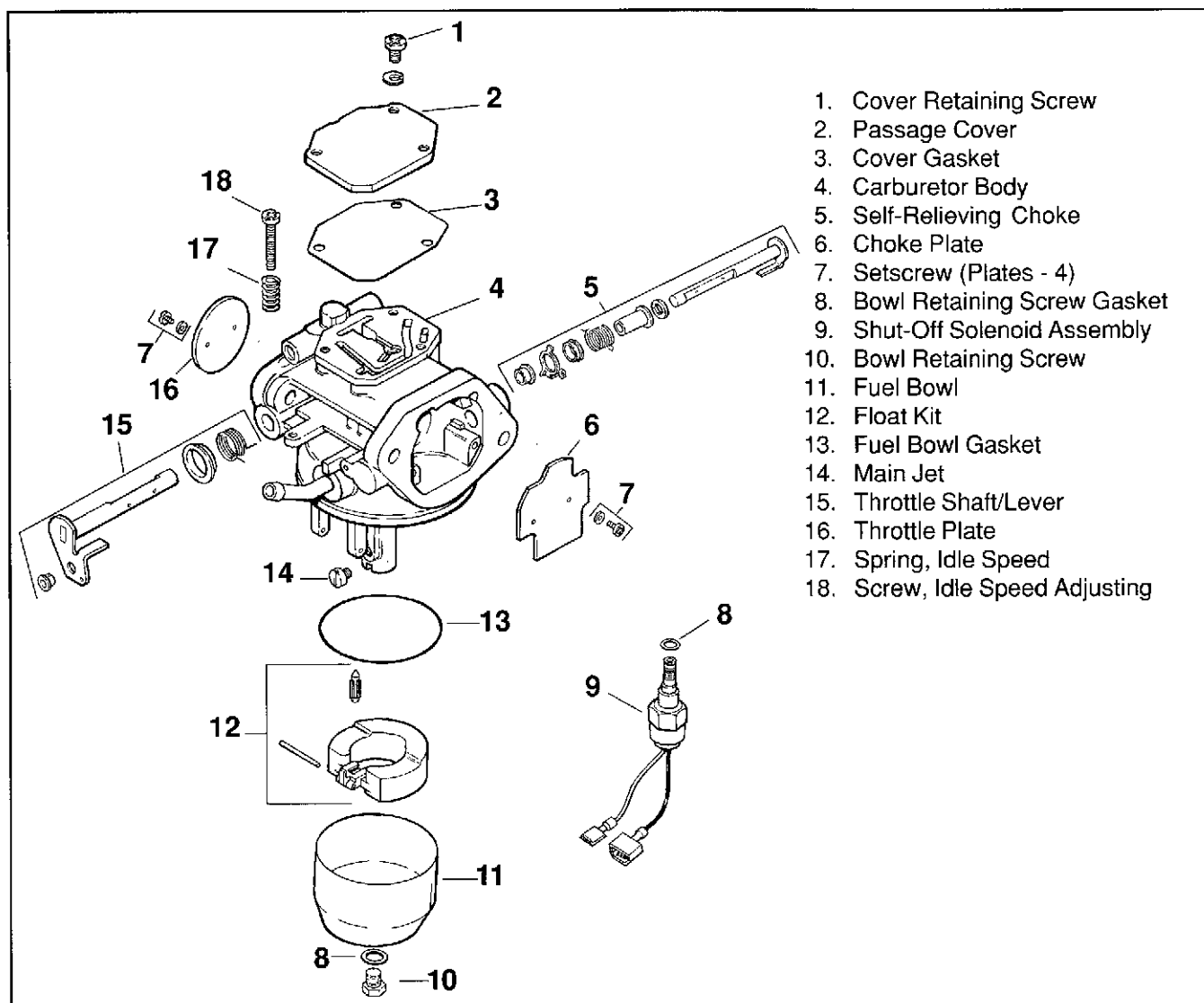


Figure 5-7. Carburetor - Exploded View.

**Inspection/Repair**

To clean vent ports, seats, etc., use a good commercially available carburetor solvent, such as Gumout™, and clean, dry, compressed air to blow out internal channels and port. Use a suitable shop rag to prevent debris from hitting someone.

Carefully inspect all components and replace those that are worn or damaged.

- Inspect the carburetor body for cracks, holes, and other wear or damage.
- Inspect the float for cracks, holes, and missing or damaged float tabs. Check the float hinge and shaft for wear or damage.
- Inspect the fuel inlet needle and seat for wear or damage.
- The choke plate is spring loaded. Check to make sure it moves freely on the shaft.

Always use new gaskets when servicing or reinstalling carburetors. Repair kits are available which include new gaskets and other components. These kits are described below.

Refer to the Parts Manual for the engine being serviced to ensure the correct repair kits and replacement parts are used. The Kohler part number is stamped on the choke side flange on top of the carburetor body.

**Overhaul Kit With Gaskets Contains:**

Qty.	Description
1	Gasket, air cleaner base
1	Gasket, carburetor
1	Screw, throttle adjusting
1	Gasket, chamber screw
1	Screw, idle adjusting
1	Float
1	Pin, float
1	Valve, float
1	Gasket, float chamber
1	Spring, throttle adjusting screw
1	Spring, idle adjusting screw
1	Gasket, passage cover

**Choke Repair Kit With Gaskets Contains:**

Qty.	Description
1	Gasket, air cleaner base
1	Gasket, carburetor
2	Screw, valve set
1	Valve, choke
1	Filter, choke shaft
1	Spring, choke arm return
1	Ring, choke lever
1	Collar, choke
1	Shaft, choke assembly
1	Lever, choke assembly

**Gasket Kit With Gaskets Contains:**

Qty.	Description
1	Gasket, air cleaner base
1	Gasket, carburetor
1	Gasket, chamber screw
1	Gasket, float chamber
1	Gasket, passage cover

**Solenoid Replacement Kit With Gaskets Contains:**

Qty.	Description
1	Gasket, air cleaner base
1	Gasket, carburetor
1	Gasket, solenoid
1	Gasket, chamber screw
1	Holder, solenoid
1	Valve, solenoid

**Reassembly Procedure**

Reassembly is essentially the reverse of the disassembly procedure. Use new gaskets, springs, and adjusting screws as provided in the repair kit. Also use new carburetor and intake manifold gaskets.

## Section 5

# Fuel System and Governor

### Governor

#### General

The #2 side camshaft is equipped with a centrifugal flyball mechanical governor. It is designed to hold the engine speed constant under changing load conditions. The governor works as follows:

- Centrifugal force acting on the rotating governor assembly causes the flyballs to move outward as speed increases.
- As the flyballs move outward, they exert increasing pressure against the cover and bushing.
- The bushing contacts the yoke on the cross shaft causing the shaft to rotate.
- One end of the cross shaft protrudes through the crankcase. The rotating action of the cross shaft is transmitted to the throttle lever of the carburetor through the governor lever and external linkage.

- When the engine is at rest, and the throttle is in the "fast" position, the tension of the governor spring holds the throttle plate open. When the engine is operating and the governor assembly is rotating, the force applied against the cross shaft tends to close the throttle plate. The governor spring tension and the force applied by the bushing balance each other during operation to maintain engine speed.
- When load is applied and the engine speed and governor speed decrease, the governor spring tension moves the governor lever to open the throttle plate wider. This allows more fuel into the engine, increasing engine speed. As speed reaches the governed setting, the governor spring tension and the force applied by the bushing will again offset each other to hold a steady engine speed.

### Adjustments

#### General

The governed speed setting is determined by the position of the throttle control. It can be variable or constant, depending on the engine application.

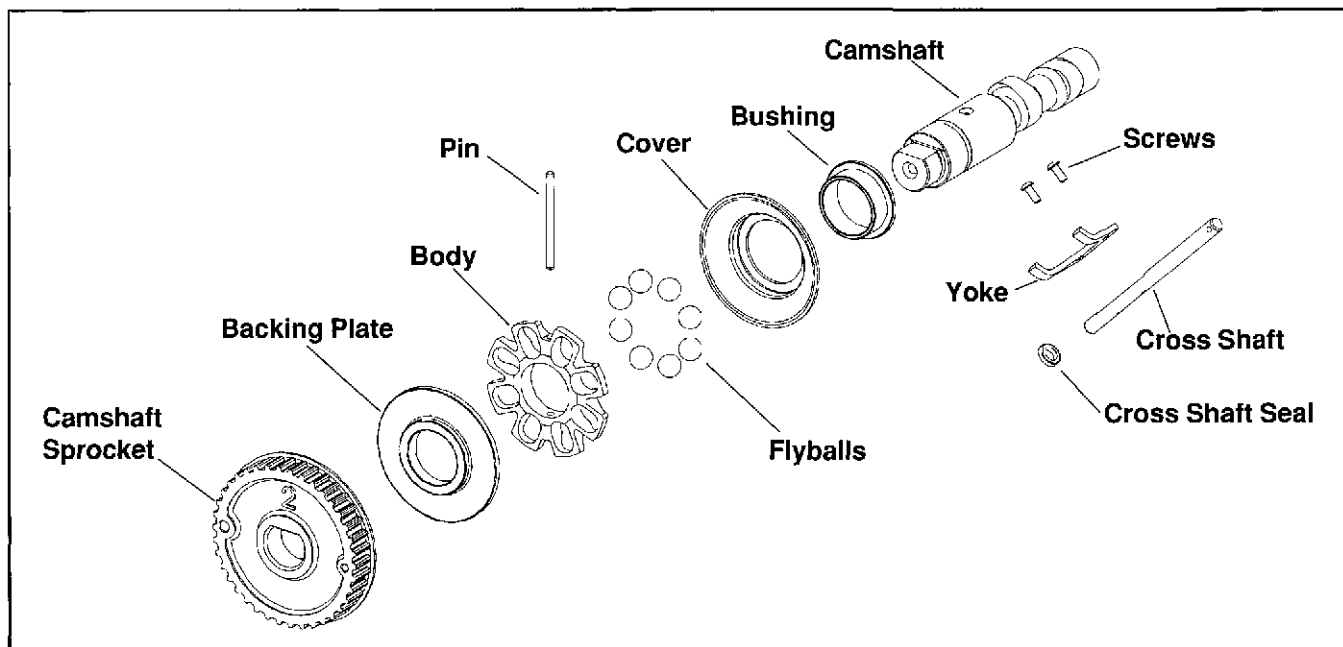


Figure 5-8. Internal Governor Components on #2 Side Camshaft.

### Initial Adjustment

Make this adjustment whenever the governor lever is loosened or removed from the cross shaft. Adjust as follows:

1. Make sure the throttle linkages are connected to the governor lever, the bellcrank, and the throttle lever on the carburetor.
2. Loosen the hex. nut holding the governor lever to the cross shaft.
3. Move the governor lever **TOWARDS** the throttle control bracket as far as it will move (wide open throttle) and hold in position.
4. Insert a nail into the hole on the cross shaft and rotate the shaft **COUNTERCLOCKWISE** as far as it will turn, then tighten hex. nut securely.

### Sensitivity Adjustment

Governor sensitivity is adjusted by repositioning the governor spring in the holes on the governor lever. If speed surging occurs with a change in engine load, the governor is set too sensitive. If a big drop in speed occurs when normal load is applied, the governor should be set for greater sensitivity. Adjust as follows:

1. To increase the sensitivity, move the spring closer to the governor lever pivot point.
2. To decrease the sensitivity, move the spring away from the governor lever pivot point.

# Section 6 Lubrication System

## General

This engine uses a full pressure lubrication system. This system delivers oil under pressure to the crankshaft, camshafts, and connecting rod bearing surfaces.

A high-efficiency gerotor pump is located in the crankcase. The oil pump maintains high oil flow and oil pressure, even at low speeds and high operating temperatures. A pressure relief valve in the crankcase limits the maximum pressure of the system.

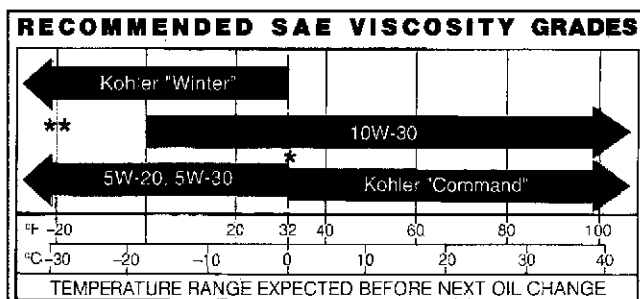
## Service

The two crankcase halves must be separated to service the oil pickup or the pressure relief valve. Refer to the appropriate procedures in Section 9.

## Oil Recommendations

Using the proper type and weight of oil in the crankcase is extremely important; so is checking oil daily and changing the oil and filter regularly.

Use high-quality detergent oil of **API (American Petroleum Institute) service class SG or SH**. Select the viscosity based on the air temperature at the time of operation as shown in the following table.



\*Use of synthetic oil having 5W-20 or 5W-30 rating is acceptable, up to 40°F.  
 \*\*Synthetic oils will provide better starting in extreme cold (below -10°F).

NOTE: Using other than service class SG or SH oil or extending oil change intervals longer than recommended can cause engine damage.

A logo or symbol on oil containers identifies the API service class and SAE viscosity grade. See Figure 6-1.

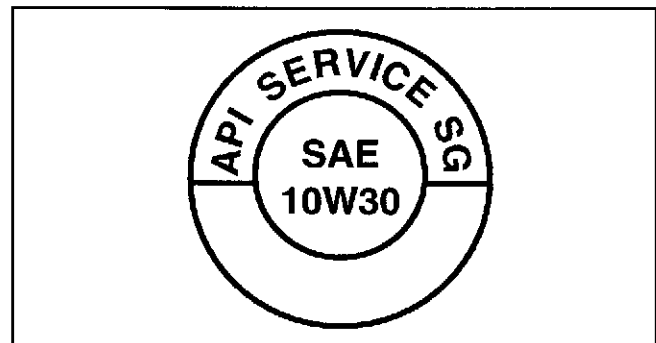


Figure 6-1. Oil Container Logo.

The top position of the symbol shows service class such as **API SERVICE CLASS SG**. The symbol may show additional categories such as **SH, CC, or CD**. The center portion shows the viscosity grade such as **SAE 10W-30**. If the bottom portion shows "Energy Conserving," it means that oil is intended to improve fuel economy in passenger car engines.

## Checking Oil Level

The importance of checking and maintaining the proper oil level in the crankcase cannot be overemphasized. Check oil **BEFORE EACH USE** as follows:

1. Make sure the engine is stopped, level, and cool so the oil has had time to drain into sump.
2. Clean the area around the dipstick before removing it. This will help to keep dirt, grass clippings, etc., out of the engine.

## Section 6 Lubrication System

3. Remove the dipstick; wipe oil off. Reinsert the dipstick into the tube until fully seated. See Figure 6-2.

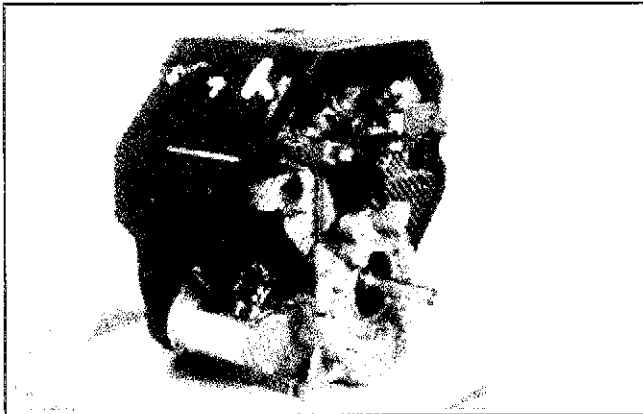


Figure 6-2. Location of Dipstick and Oil Drain Plug (Starter Side).

4. Remove dipstick and check oil level. The level should be between the "F" and "L" marks. If low, add oil of proper type up to the full mark. Reinstall oil fill cap and dipstick.

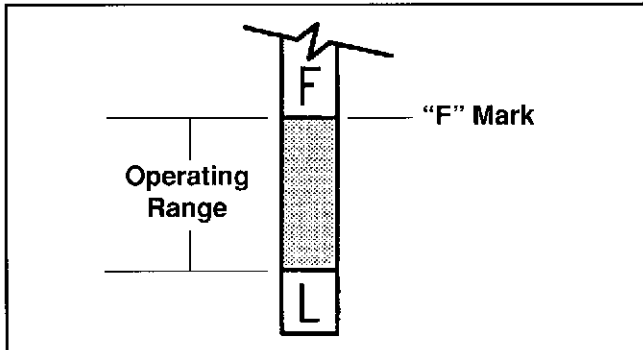


Figure 6-3. Oil Level Marks on Dipstick.

NOTE: To prevent extensive engine wear or damage, always maintain the proper oil level in the crankcase. Never operate the engine with the oil level below the "L" mark or above the "F" mark on the dipstick.

### Oil Change: Overhead Valve

**For New Engines** - change oil after the first **5 hours** of operation; then every **100 hours** of operation thereafter.

**For Overhauled Engines or those rebuilt with a new Short Block or Miniblock** - use 10W-30 weight (Kohler "Command") - service class SG or SH for the first **5 hours** of operation. Change the oil after this initial run-in period. Refill with service class SG or SH oil of viscosity specified under "Oil Types."

When changing oil, drain oil while the engine is still warm from operation. The oil will flow more freely and carry away more impurities. Tilt the engine slightly toward the oil drain and allow ample time for complete drainage. After draining, reinstall drain plug. Fill with proper oil to the "F" mark on the dipstick. Always check the level with the dipstick before adding more oil. Make sure engine is level when filling and checking oil.

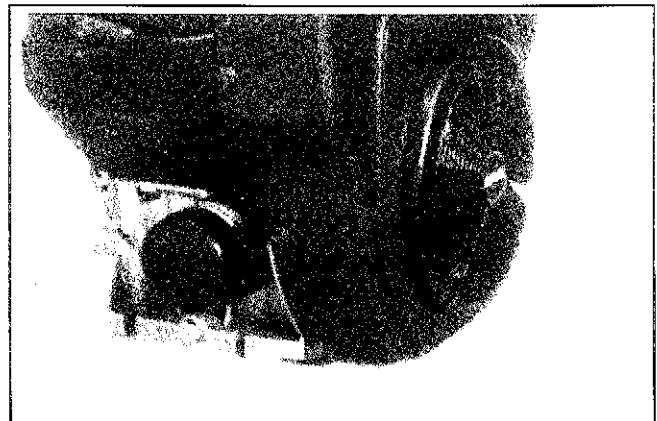


Figure 6-4. Location of Oil Drain on Oil Filter Side.

Change the oil as follows:

1. Clean the areas around the drain plug, dipstick, and oil fill cap.
2. Remove one of the oil drain plugs. A drain plug is located on either side of the crankcase; one is below the oil filter, and the other is below the starter. See Figure 6-4.
3. Allow all oil to drain and then reinstall the drain plug. Torque to **13.6 N·m (10 ft. lb.)**.
4. Remove the oil fill cap and fill the engine with the proper oil to the "F" mark on the dipstick. Always check the oil level with the dipstick before adding more oil.
5. Reinstall the oil fill cap.

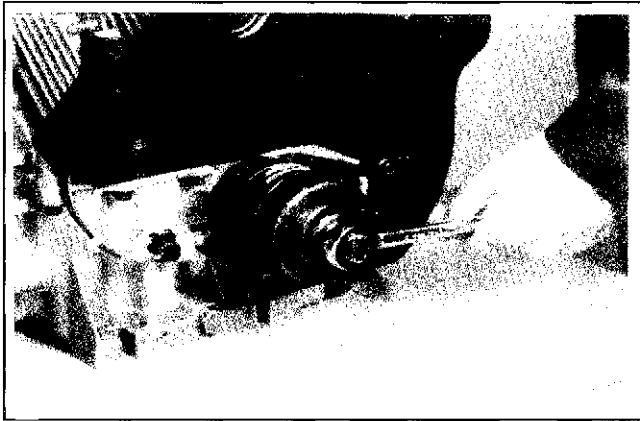


Figure 6-5. Removing Oil Filter.



Figure 6-6. Hand Tighten New Filter in Clockwise Direction.

### Changing Oil Filter

Replace the oil filter **at least every other oil change (every 200 hours of operation)**. *Always use a genuine Kohler oil filter.*

Change the oil filter as follows (see Figures 6-5 and 6-6):

1. Clean areas around drain plug, oil filter, dipstick, and oil fill cap.
2. Remove one of the oil drain plugs. A drain plug is located on either side of the crankcase; one is below the oil filter, the other is below the starter.
3. Allow all the oil to drain and then reinstall the drain plug. Tighten to **13.6 N·m (10 ft. lb.)**.
4. Remove the old filter and wipe off the filter adapter with a clean cloth.
5. Place a new replacement filter in a shallow pan with the open end up. Pour new oil of the proper type in through the threaded center hole. Stop pouring when the oil reaches the bottom of the threads. Allow a minute or two for the oil to be absorbed by the filter material.
6. Put a drop of oil on your fingertip and wipe it on the rubber gasket.

7. Install the new oil filter to the filter adapter. Hand tighten the filter clockwise until the rubber gasket contacts the adapter, then tighten the filter an additional 1/2 turn.
8. Remove the oil fill cap and fill the engine with the proper oil to the "F" mark on the dipstick. Always check the oil level with the dipstick before adding more oil.

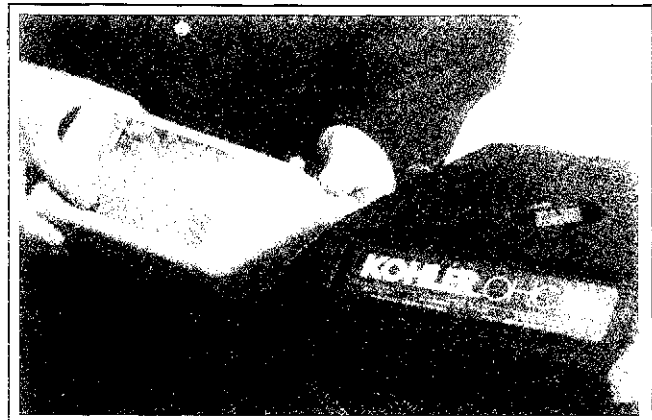


Figure 6-7. Replenish Oil to Proper Level.

## Section 6 Lubrication System

---



Figure 6-8. Reinstall Dipstick.

8. Reinstall the oil fill cap and dipstick.
9. Start the engine and check for oil leaks. Stop the engine, allow a minute for the oil to drain down, and recheck the level on the dipstick.

### Oil Sentry™

#### General

Some engines are equipped with an optional Oil Sentry™ oil pressure switch monitor. If the pressure decreases below an acceptable level, the Oil Sentry™ will either shut off the engine or activate a warning signal, depending on the application.

The pressure switch is designed to break contact as the oil pressure increases, and make contact as the oil pressure decreases. At oil pressure above approximately 3.0/5.0 psig, the switch contacts open. Below this pressure, the switch contacts close.

On stationary or unattended applications (pumps, generators, etc.), the pressure switch can be used to ground the ignition module to stop the engine. On vehicular applications (lawn tractors, mowers, etc.) the pressure switch can only be used to activate a "low oil" warning light.

**NOTE:** Make sure the oil level is checked BEFORE EACH USE and is maintained up to the "F" mark on the dipstick. This includes engines equipped with Oil Sentry™.

#### Installation

The Oil Sentry™ pressure switch is installed in the oil filter adapter.

On engines not equipped with Oil Sentry™ the installation hole is sealed with a 1/8-27 N.P.T.F. pipe plug.

To install new switch, follow these steps:

1. Apply pipe sealant with teflon to the threads of the switch.
2. Hand start the switch into the tapped hole in the oil filter adapter. See Figure 6-6.
3. Torque the switch to a maximum **3.4 N·m (30 in. lb.)**. **Do not overtighten or you will crack the adapter.**

#### Testing

Compressed air, a pressure regulator, pressure gauge, and a continuity tester are required to test the switch.

1. Connect the continuity tester across the blade terminal and the metal case of the switch. With **0 psig** pressure applied to the switch, the tester should indicate **continuity (switch closed)**.
2. Gradually increase the pressure to the switch. As pressure increases through the range of **3.0/5.0 psig**, the tester should indicate a change to **no continuity (switch open)**. The switch should remain open as the pressure is increased to **90 psig maximum**.
3. Gradually decrease the pressure through the range of **3.0/5.0 psig**. The tester should indicate a change to **continuity (switch closed) down to 0 psig**.
4. Replace the switch if it does not operate as specified.



## Section 7

# Retractable Starter

**⚠ WARNING: Spring Under Tension!**

Retractable starters contain a powerful, recoil spring that is under tension. Always wear safety goggles when servicing retractable starters and carefully follow instructions in this section for relieving spring tension.

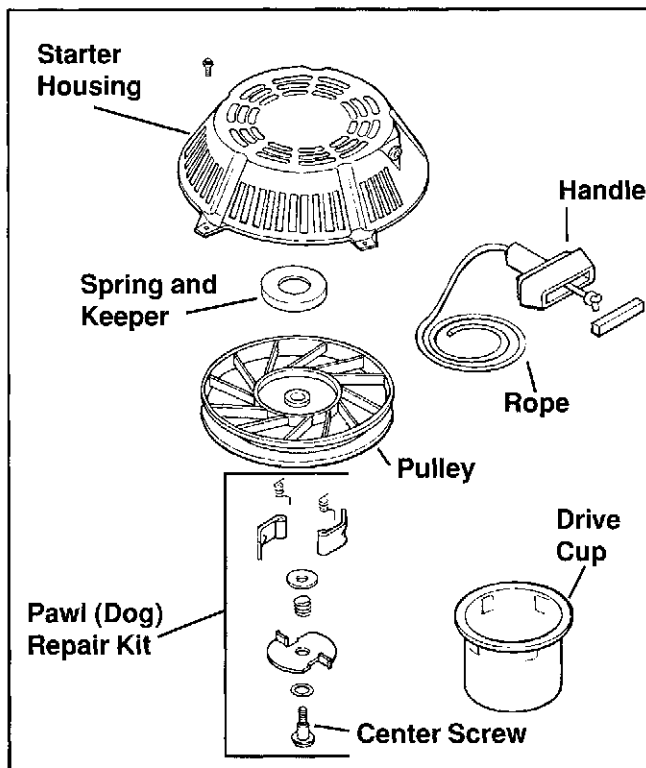


Figure 7-1. Retractable Starter – Exploded View.

### To Remove Starter

1. Remove the five hex. flange screws securing the starter to blower housing. See Figure 7-2.
2. Remove the starter.

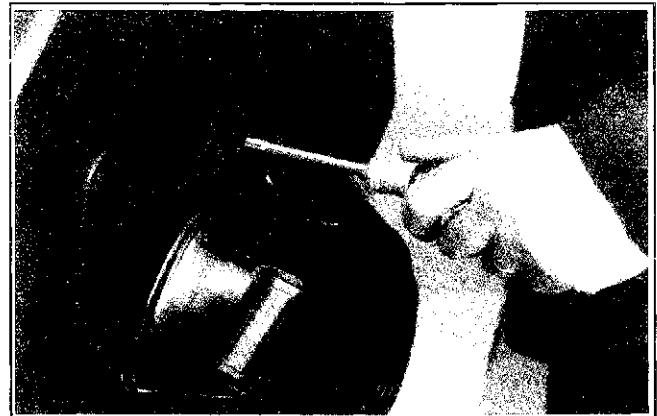


Figure 7-2. Removing Retractable Starter.

### To Install Starter

1. Install the retractable starter and five hex. flange screws to blower housing. Leave the screws slightly loose.
2. Pull the starter handle out until the pawls engage in the drive cup. Hold the handle in this position and tighten the screws securely.

### Rope Replacement

The rope can be replaced *without* complete starter disassembly.

1. Remove the starter from the engine blower housing.
2. Pull the rope out approximately 12" and tie a temporary (slip) knot in it to keep it from retracting into the starter. See Figure 7-3.

## Section 7 Retractable Starter

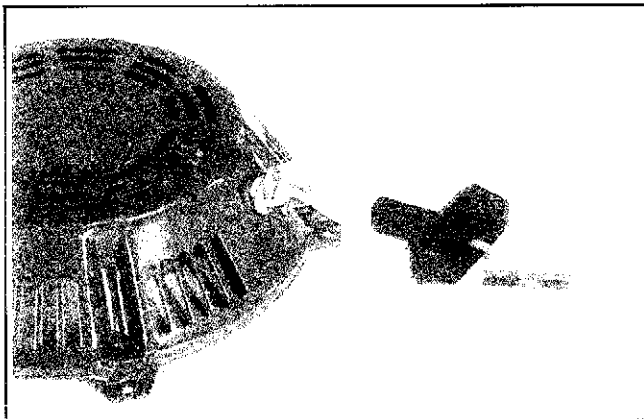


Figure 7-3. Removing Starter Handle.

3. Remove the rope retainer from inside the starter handle. Untie the single knot and remove the rope retainer and handle.
4. Hold the pulley firmly and untie the slip knot. Allow the pulley to rotate slowly as the spring tension is released.
5. When all spring tension on the starter pulley is released, remove the rope from pulley.
6. Tie a single knot in one end of the new rope.
7. Rotate the pulley counterclockwise (when viewed from pawl side of pulley) until the spring is tight. (Approximately 6 full turns of pulley.)
8. Rotate the pulley clockwise until the rope hole in pulley is aligned with rope guide bushing of starter housing.

**NOTE:** Do not allow the pulley/spring to unwind. Enlist the aid of a helper if necessary, or use a C-clamp to hold the pulley in position.

9. Insert the new rope through the rope hole in starter pulley and rope guide bushing of housing. See Figure 7-4.

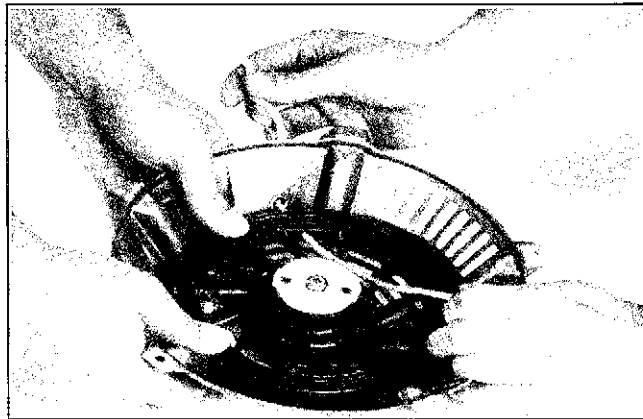


Figure 7-4. Installing Rope.

10. Tie a slip knot approximately 12" from the free end of rope. Hold the pulley firmly and allow it to rotate slowly until the slip knot reaches the guide bushing of housing.
11. Slip the handle and rope retainer onto the rope. Tie a single knot at the end of the rope. Install the rope retainer into the starter handle.
12. Untie the slip knot and pull on the handle until the rope is fully extended. Slowly retract the rope into the starter.

When the spring is properly tensioned, the rope will retract fully and the handle will stop against the starter housing.

### Pawls (Dogs) Replacement

To replace the pawls, follow disassembly steps 1-4 and reassembly steps 3-8 on the following pages. A pawl repair kit is available which includes the following components:

#### Pawl Repair Kit

Qty.	Description
1	Dog Cam
1	Center Screw
2	Pawl (Dog) Spring
1	Brake Spring
2	Starter Pawl (Dog)
1	Brake Washer
1	Washer

## Disassembly

**⚠ WARNING: Spring Under Tension!**

Do not remove the center screw from starter until the spring tension is released. Removing the center screw before releasing spring tension, or improper starter disassembly, can cause the sudden and potentially dangerous release of the spring. Follow these instructions carefully to ensure personal safety and proper starter disassembly. Make sure adequate face protection is worn by all persons in the area.

1. Release spring tension and remove the handle and starter rope. (Refer to "Rope Replacement," steps 2 through 5 on pages 7.1 and 7.2.)
2. Remove the center screw, washer, and pawl retainer. See Figure 7-5.
3. Remove the brake spring and brake washer. See Figure 7-6.
4. Carefully note the positions of the pawls and pawl springs before removing them.

Remove the pawls and pawl springs from the starter pulley.

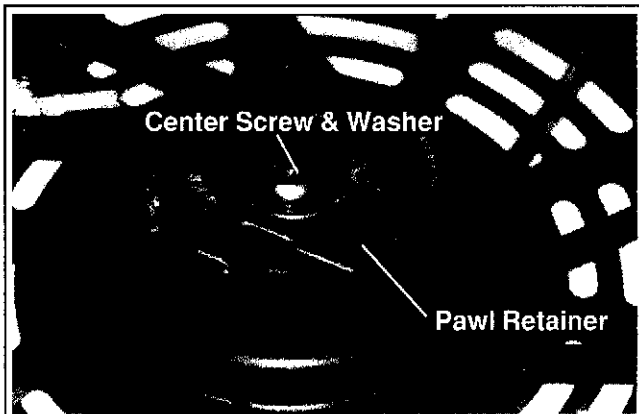


Figure 7-5. Center Screw, Washer and Pawl Retainer.

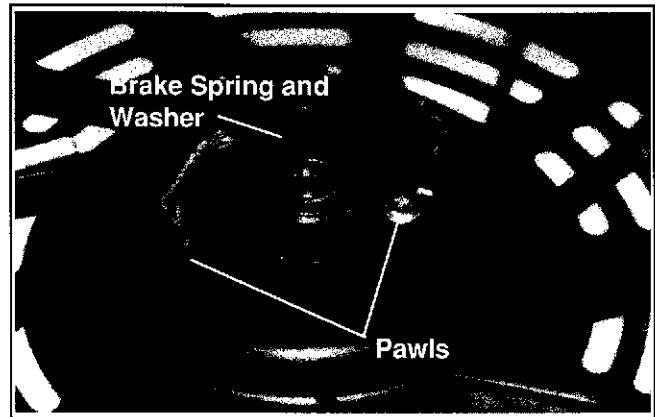


Figure 7-6. Brake Spring and Washer and Pawls.

5. Rotate the pulley **clockwise 2 full turns**. This will ensure the spring is disengaged from the starter housing.
6. Hold the pulley into the starter housing. Invert the pulley/housing so the pulley is away from your face, and away from others in the area.
7. Rotate the pulley slightly from side to side and carefully separate the pulley from the housing. See Figure 7-7.

If the pulley and the housing do not separate easily, the spring could be engaged in the starter housing, or there is still tension on the spring. Return the pulley to the housing and repeat step 5 before separating the pulley and housing.

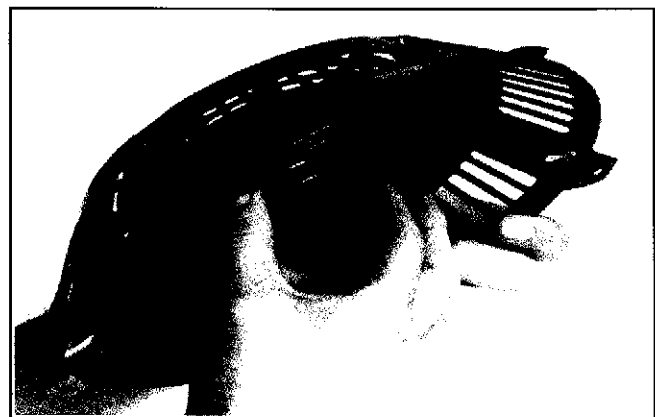


Figure 7-7. Removing Pulley from Housing.

## Section 7

### Retractable Starter

- Note the position of the spring and keeper assembly in the pulley. See Figure 7-8.

Remove the spring and keeper assembly from the pulley as a package.

**⚠ WARNING: Spring Under Tension!**

*Do not remove the spring from the keeper. Severe personal injury could result from the sudden uncoiling of the spring.*

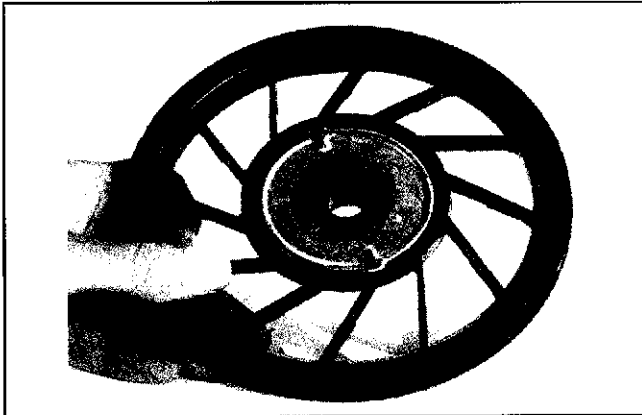


Figure 7-8. Position of Spring and Keeper in Pulley.

#### Inspection and Service

- Carefully inspect the rope, pawls, housing, center screw, and other components for wear or damage.
- Replace all worn or damaged components. Use only genuine Kohler replacement parts as specified in the Parts Manual. All components shown in Figure 7-1 are available as service parts. Do not use nonstandard parts.
- Do not attempt to rewind a spring that has come out of the keeper. Order and install a new spring and keeper assembly.
- Clean all old grease and dirt from the starter components. Generously lubricate the spring and center shaft with any commercially available bearing grease.

#### Reassembly

- Make sure the spring is well lubricated with grease. Place the spring and keeper assembly inside the pulley (with spring towards pulley). See Figure 7-9.
- Install the pulley with spring and keeper assembly into the starter housing. See Figure 7-9.

Make sure the pulley is fully seated against the starter housing. Do not wind the pulley and recoil spring at this time.

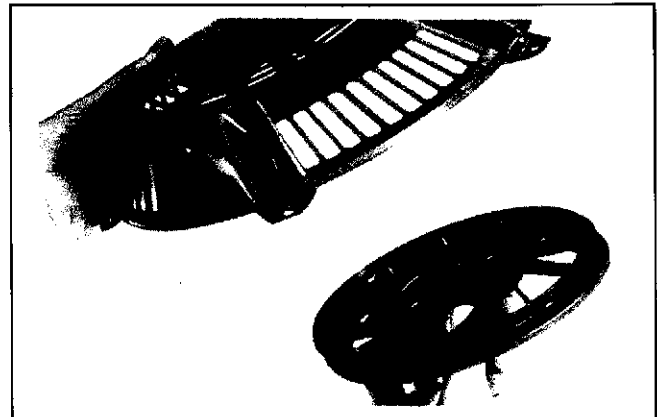


Figure 7-9. Installing Pulley and Spring into Housing.

- Install the pawl springs and pawls into the starter pulley. See Figure 7-10.

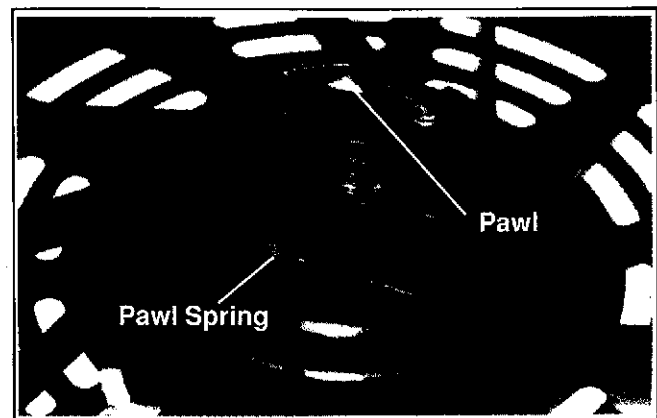


Figure 7-10. Installing Pawls and Pawl Springs.

- Place the brake washer in the recess in starter pulley; over the center shaft.

## Section 7 Retractable Starter

5. Lubricate the brake spring sparingly with grease. Place the spring on the plain washer. (Make sure the threads in center shaft remain clean, dry, and free of grease and oil.)
6. Apply a small amount of **Loctite® No. 271** to the threads of the center screw. Install the center screw, with washer and retainer, to the center shaft. Torque the screw to **7.4/8.5 N·m (65/75 in. lb.)**.
7. Tension the spring and install the rope and handle as instructed in steps 6 through 12 under "Rope Replacement" on page 7.2.
8. Install the starter to the engine blower housing. See Figure 7-11.

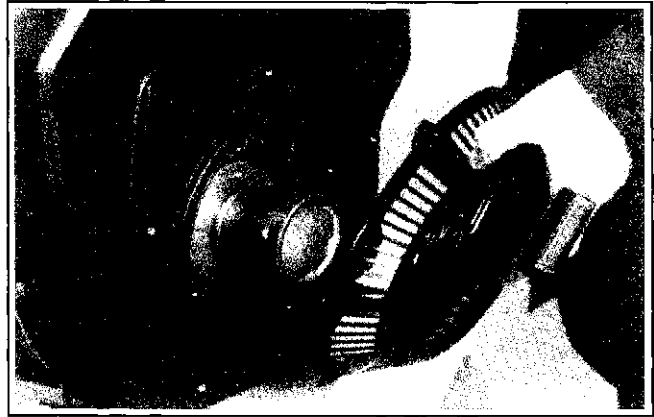


Figure 7-11. Installing Retractable Starter.

## Section 8

# Electrical System and Components

This section covers the operation, service and repair of the electrical system components. Systems and components covered in this section are:

- Spark Plugs
- Battery and Charging System
- Electronic CD Ignition System
- Electric Starter

### Spark Plugs

Engine misfire or starting problems are often caused by a spark plug that has improper gap setting or is in poor condition.

The engine is equipped with the following spark plugs:

<b>Type:</b>	Champion® RC12YC (or equivalent)
<b>Gap:</b>	0.76 mm (0.030 in.)
<b>Thread Size:</b>	14 mm
<b>Reach:</b>	19.1 mm (3/4 in.)
<b>Hex. Size:</b>	15.9 mm (5/8 in.)

### Spark Plug Service

Every **200 hours** of operation, remove each spark plug. Check its condition and either reset the gap or replace with a new plug as necessary. To service the plugs, perform the following steps:

1. Before removing each spark plug, clean the area around the base of the plug to keep dirt and debris out of the engine.

2. Remove the plug and check its condition. See "Inspection" following this procedure. Replace the plug if necessary.

**NOTE:** Do not clean spark plug in a machine using abrasive grit. Some grit could remain in the spark plug and enter the engine causing extensive wear and damage.

3. Check the gap using a wire feeler gauge. Adjust the gap to **0.76 mm (0.030 in.)** by carefully bending the ground electrode. See Figure 8-1.

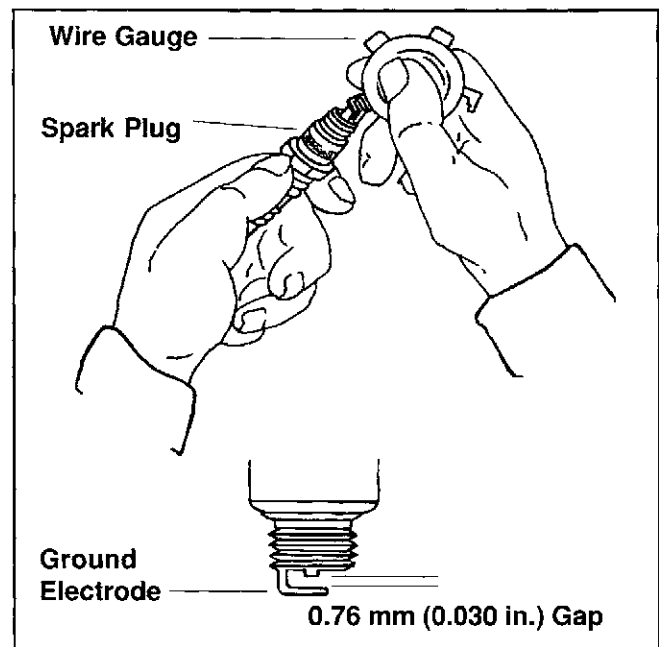


Figure 8-1. Servicing Spark Plug.

4. Reinstall the spark plug into the cylinder head and tighten to **24.4/29.8 N·m (18/22 ft. lb.)**.

## Section 8

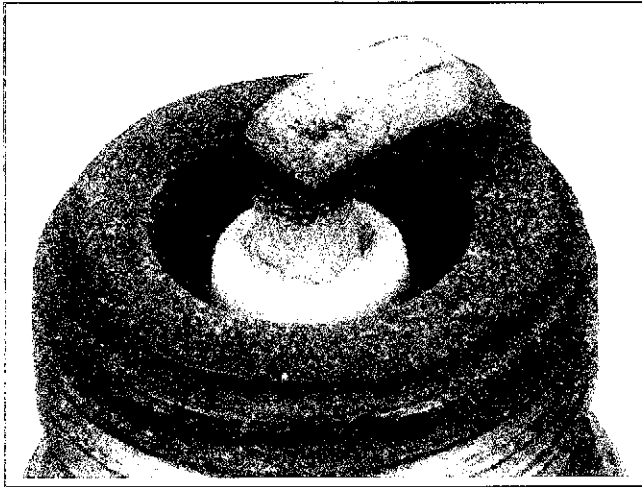
### Electrical System and Components

---

#### Inspection

Inspect each spark plug as it is removed from the cylinder head. The deposits on the tip are an indication of the general condition of the piston rings, valves, and carburetor.

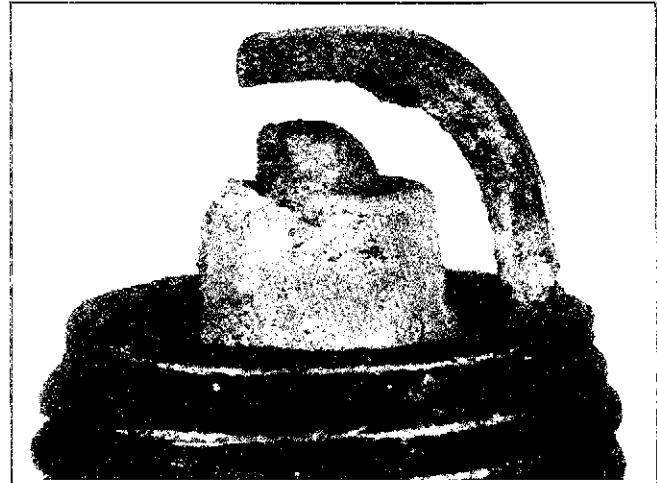
Normal and fouled plugs are shown in the following photos:



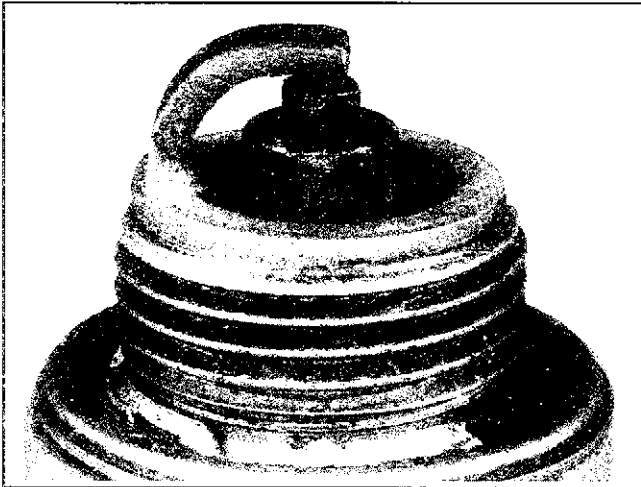
**Normal:** A plug taken from an engine operating under normal conditions will have light tan or gray colored deposits. If the center electrode is not worn, a plug in this condition could be set to the proper gap and reused.



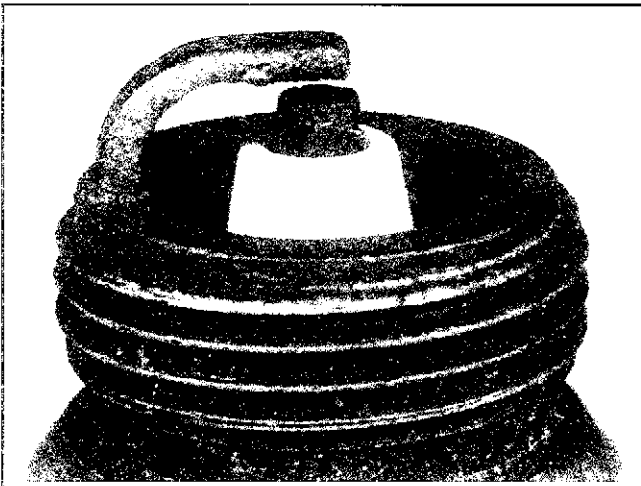
**Carbon Fouled:** Soft, sooty, black deposits indicate incomplete combustion caused by overrich carburetion, weak ignition, or poor compression.



**Worn:** On a worn plug, the center electrode will be rounded and the gap will be greater than the specified gap. Replace a worn spark plug immediately.



**Wet Fouled:** A wet plug is caused by excess fuel or oil in the combustion chamber. Excess fuel could be caused by a carburetor problem, or operating the engine with too much choke. Oil in the combustion chamber is usually caused by a breather problem, worn piston rings or valve guides.



**Overheated:** Chalky, white deposits indicate very high combustion temperatures. This condition is usually accompanied by excessive gap erosion. Lean carburetor settings, an intake air leak, or incorrect spark timing are normal causes for high combustion temperatures.

## Battery

### General

A 12 volt battery with a minimum of 250 cold-cranking amps should be sufficient for cranking. The actual cold cranking requirement depends on engine size, application and starting temperatures. Cranking requirements increase as temperatures decrease and battery capacity shrinks. Refer to the operating instructions of the equipment this engine powers for specific battery requirements.

If the battery charge is not sufficient to turn over the engine, recharge the battery.

### Battery Maintenance

Regular maintenance is necessary to prolong battery life.



#### **WARNING: Explosive Gas!**

*Batteries produce explosive hydrogen gas while being charged. To prevent a fire or explosion, charge batteries only in well ventilated areas. Keep sparks, open flames, and other sources of ignition away from the battery at all times. Keep batteries out of the reach of children. Remove all jewelry when servicing batteries.*

*Before disconnecting the negative (-) ground cable, make sure all switches are OFF. If ON, a spark will occur at the ground cable terminal which could cause an explosion if hydrogen gas or gasoline vapors are present.*

1. Regularly check the level of electrolyte. Add distilled water as necessary to maintain the recommended level.

**NOTE:** Do not overfill the battery. Poor performance or early failure due to loss of electrolyte will result.

2. Keep the cables, terminals, and external surfaces of the battery clean. A build-up of corrosive acid or grime on the external surfaces can cause the battery to self-discharge. Self-discharge occurs rapidly when moisture is present.



## Section 8

### Electrical System and Components

3. Wash the cables, terminals, and external surfaces with a mild baking soda and water solution. Rinse thoroughly with clear water.

**NOTE:** Do not allow the baking soda solution to enter the cells as this will destroy the electrolyte.

#### Battery Test

To test the battery, you will need a DC voltmeter. Perform the following steps (see Figure 8-2):

1. Connect the voltmeter across the battery terminals.
2. Crank the engine. If the battery drops below 9 volts while cranking, the battery is discharged or faulty.

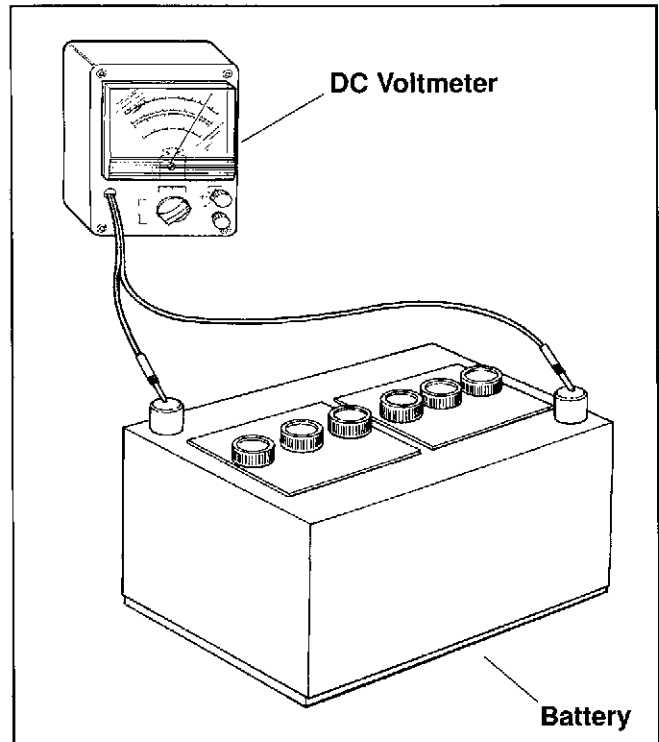


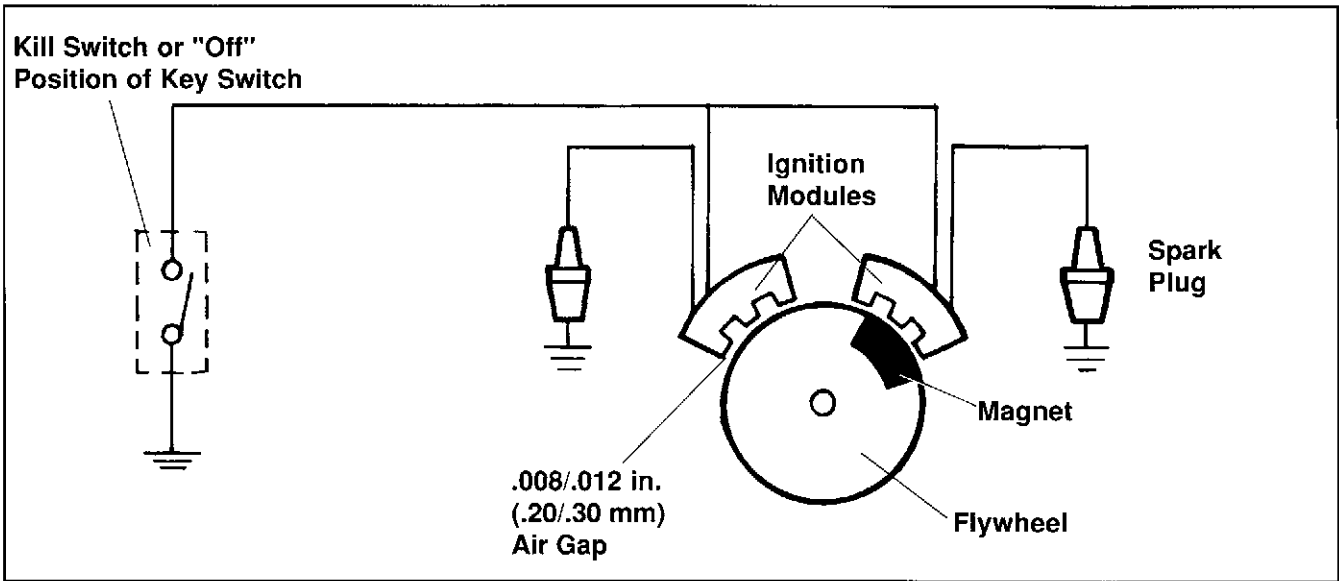
Figure 8-2. Battery Voltage Test.

### Electronic CD Ignition Systems

#### Operation of CD Ignition Systems

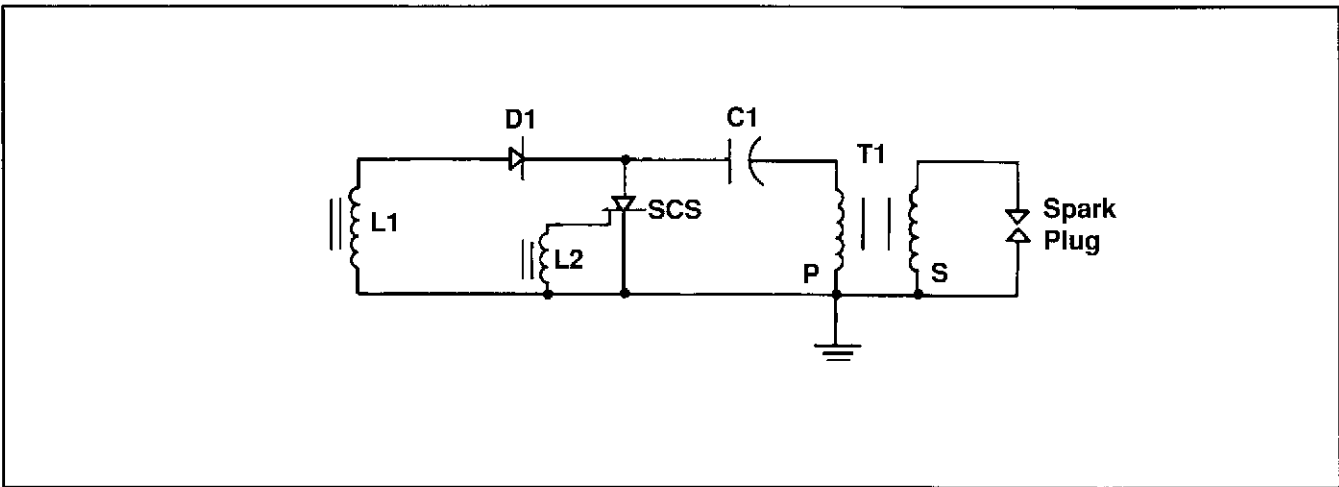
This system consists of the following components.

- A magnet assembly which is permanently affixed to the flywheel.
- Two electronic capacitive discharge ignition modules which mount on the engine crankcase (Figure 8-3).
- A kill switch (or key switch) which grounds the modules to stop the engine.
- Two spark plugs.



**Figure 8-3. Capacitive Discharge Ignition System.**

The timing of the spark is controlled directly by the location of the flywheel magnet group as referenced to engine top dead center.



**Figure 8-4. Capacitive Discharge Ignition Module.**

**Operation:** As the flywheel rotates, the magnet grouping passes the input coil (L1). The corresponding magnetic field induces energy into the input coil (L1). The resultant pulse is rectified by D1 and charges capacitor C1. As the magnet assembly completes its pass, it activates the triggering device (L2), which causes the semiconductor switch (SCS) to turn on. With the device switch "ON," the charging capacitor (C1) is directly connected across the primary (P) of the output transformer (T1). As the capacitor discharges, the current initiates a fast rising flux field in the transformer core. A high voltage pulse is generated from this action into the secondary winding of the transformer. This pulse is delivered to the spark plug gap. Ionization of the gap occurs, resulting in an arc at the plug electrodes. This spark ignites the fuel-air mixture in the combustion chamber.

## Section 8 Electrical System and Components

### Troubleshooting CD Ignition Systems

The CD ignition systems are designed to be trouble free for the life of the engine. Other than periodically checking/replacing the spark plugs, no maintenance or timing adjustments are necessary or possible.

Mechanical systems do occasionally fail or break down, however, so the following troubleshooting information is provided to help you get to the root of a reported problem.



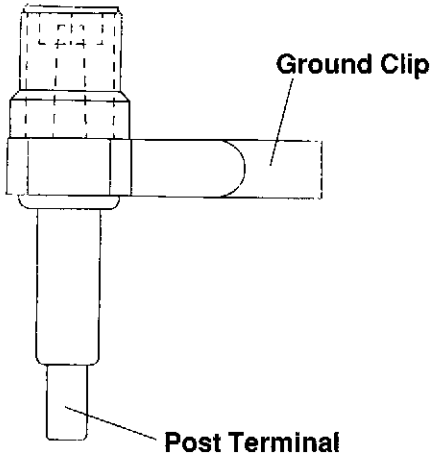
#### **WARNING: Electrical Shock!**

*Never touch electrical wires or components while the engine is running. They can be sources of electrical shock.*

Reported ignition problems are most often due to poor connections. Before beginning the test procedure, check all external wiring. Be certain all ignition-related wires are connected, including the spark plug leads. Be certain all terminal connections fit snugly. Make sure the ignition switch is in the run position.

**NOTE:** The CD ignition systems are sensitive to excessive load on the kill lead. If a customer complains of hard starting, low power, or misfire under load, it may be due to excessive draw on the kill circuit. Disconnect any auxiliary kill wires or safety switches connected to the kill circuit and operate the engine to determine if the reported problem is gone.

### Testing Procedure

Test	Conclusion
<p>1. Test for spark on both cylinders with Kohler ignition tester, Part No. 24 455 02. Disconnect one spark plug lead and connect it to the post terminal of the tester. Connect the clip to a good ground, <b>not</b> to the spark plug. Crank the engine and observe the tester spark gap. Repeat the procedure on the other cylinder. Remember to reconnect the first spark plug lead.</p> 	<p>1. If one side is not firing, check all wiring, connections, and terminations on that side. If wiring is okay, replace ignition module and retest for spark.</p> <p>If the tester shows spark, but the engine misses or won't run on that cylinder, try a new spark plug.</p> <p>If neither side is firing, check for shorted kill lead, or faulty ignition switch.</p>

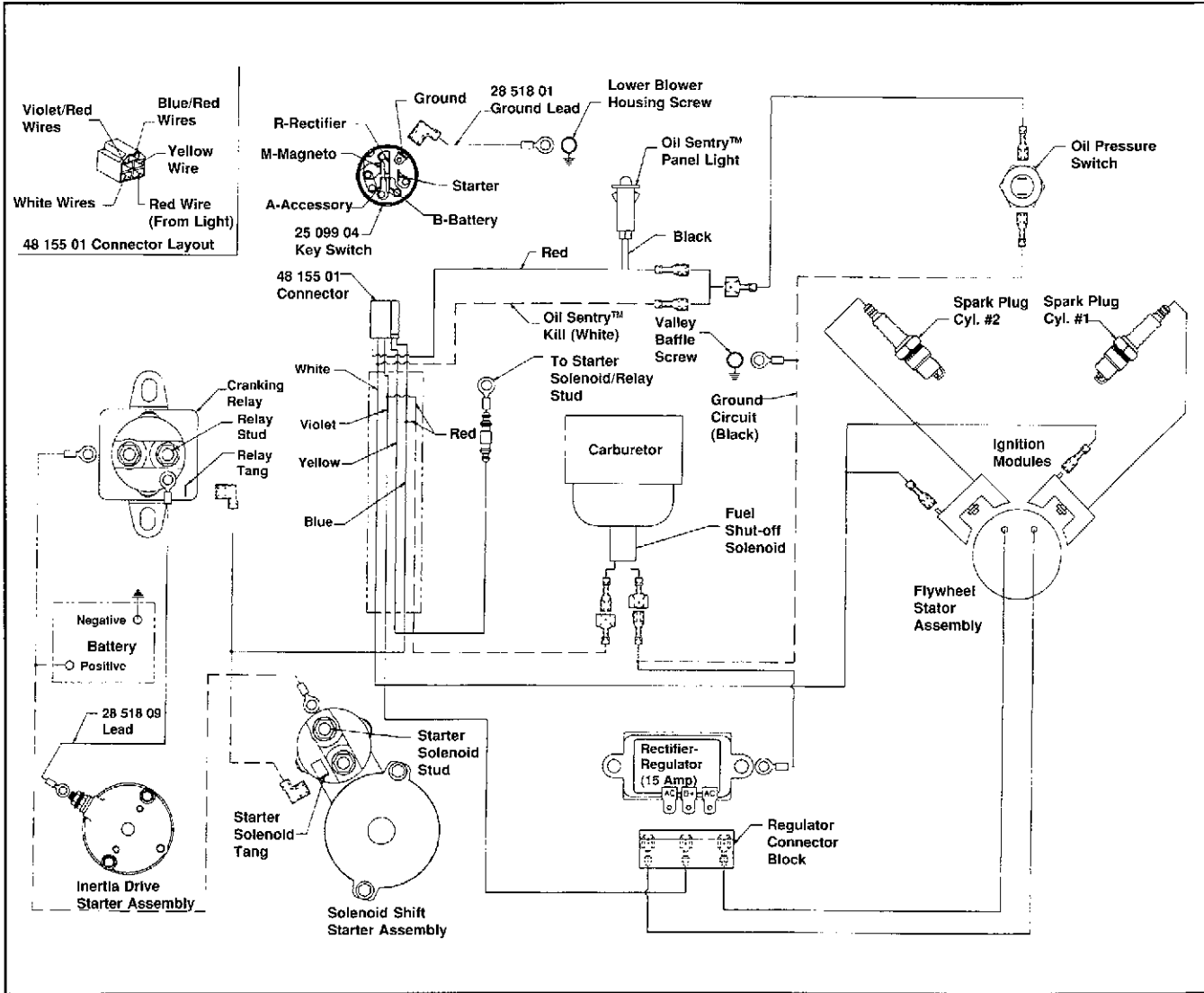
**Battery Charging Systems**

**General**

These engines are equipped with either a 15 amp or 25 amp regulated battery charging system. See Figure 8-5 for the 15 amp system with panel diagram and Figure 8-6 for the 15/25 amp system without panel diagram.

NOTE: Observe the following guidelines to avoid damage to the electrical system and components:

- Make sure the battery polarity is correct. A negative (-) ground system is used.
- Disconnect the rectifier-regulator leads and/or wiring harness plug before doing electric welding on the equipment powered by the engine. Also, disconnect other electrical accessories in common ground with the engine.
- Prevent the stator (AC) leads from touching or shorting while the engine is running. This could damage the stator.



**Figure 8-5. 15 amp Regulated Charging System With Panel.**

# Section 8

## Electrical System and Components

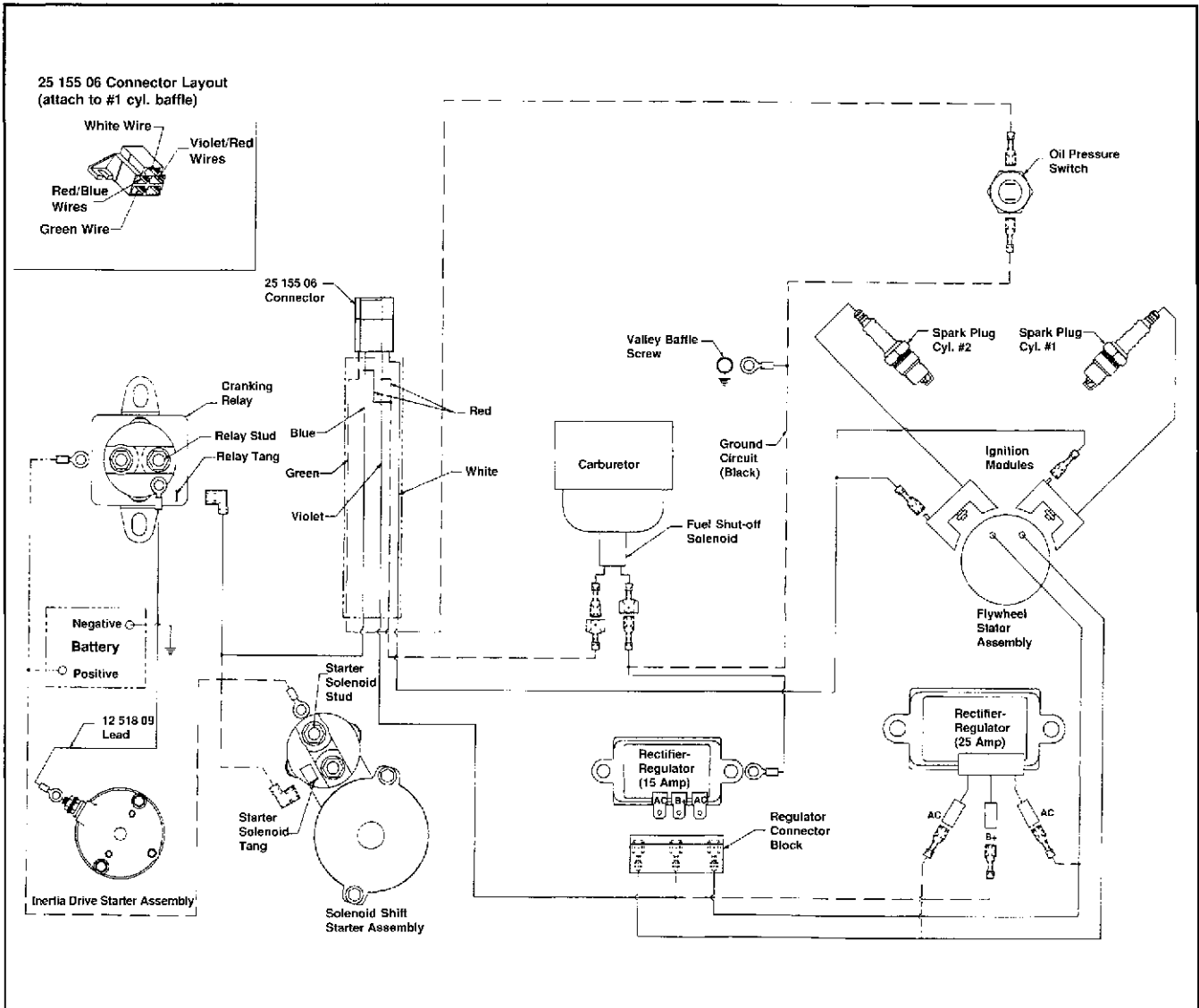


Figure 8-6. Wiring Diagram - 15/25 amp Regulated Battery Charging System Without Panel.

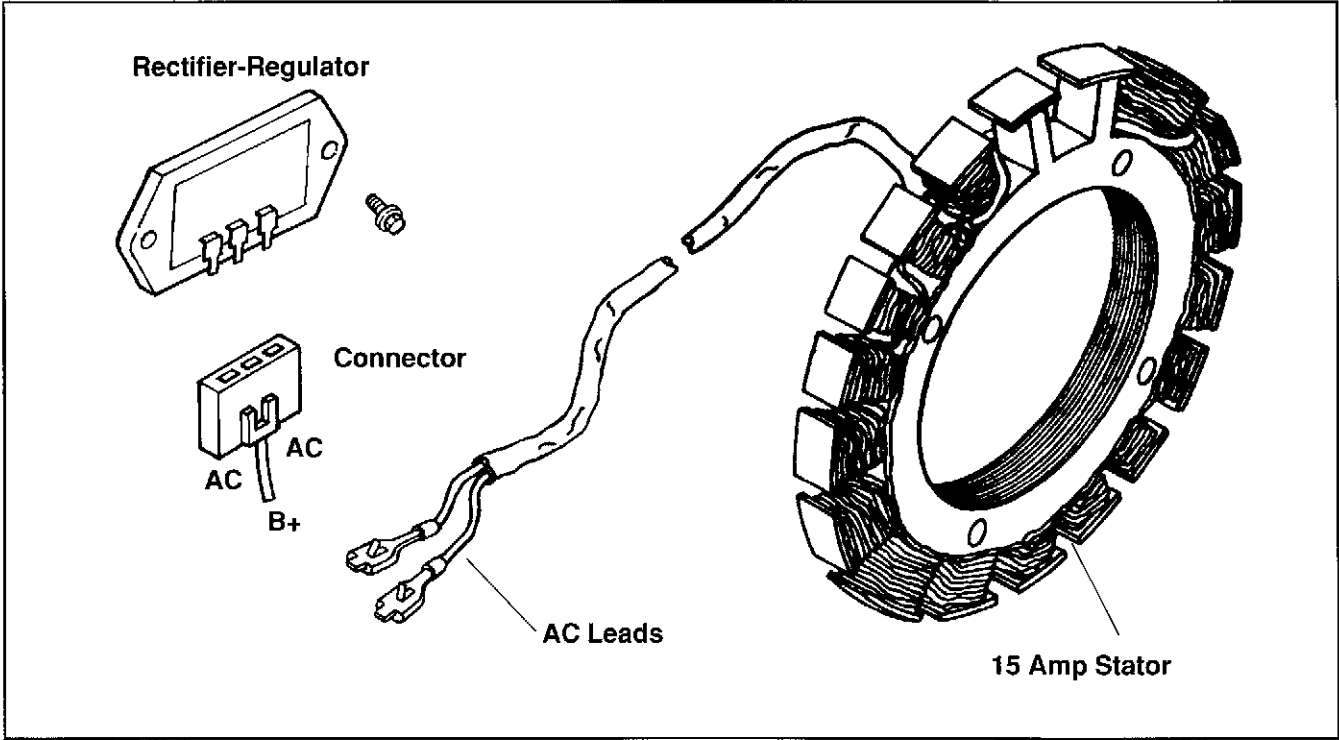


Figure 8-7. 15 amp Stator and Rectifier-Regulator.

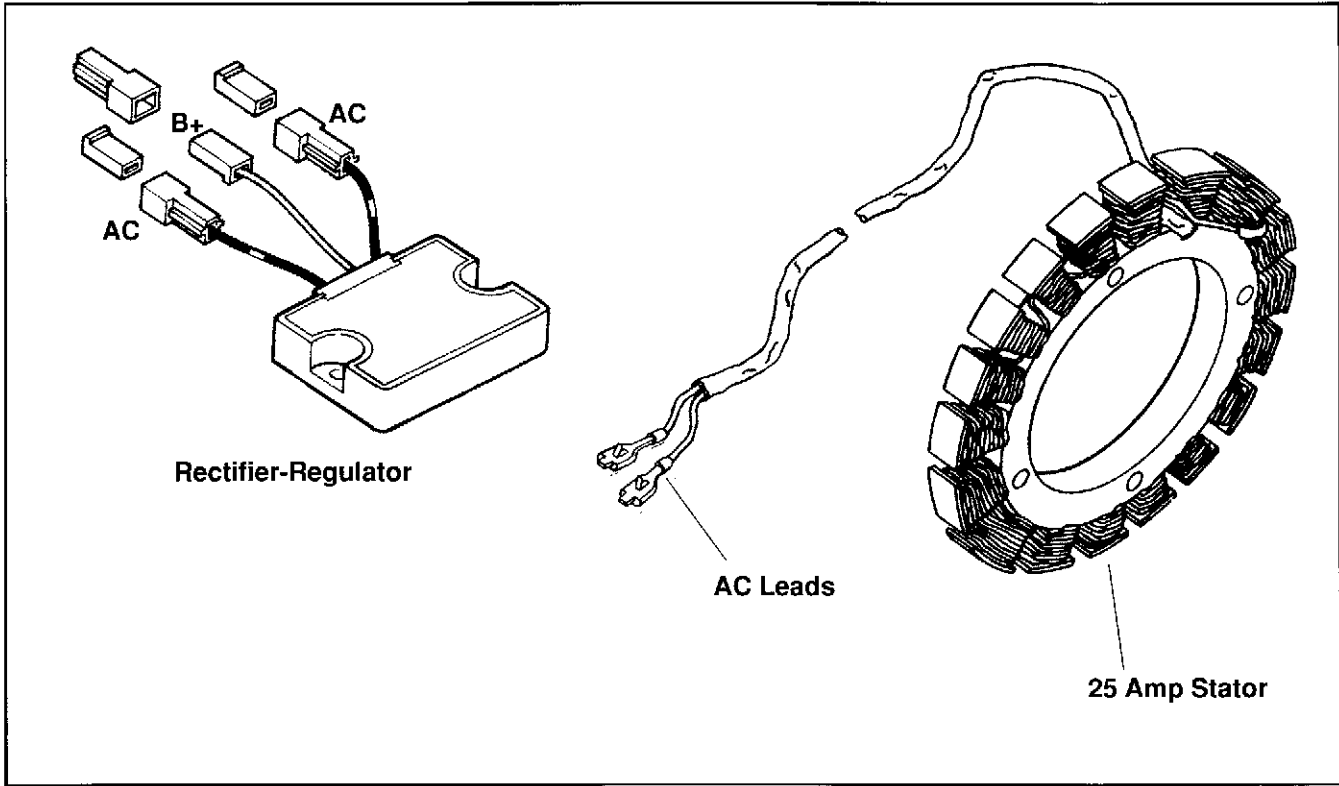


Figure 8-8. 25 amp Stator and Rectifier-Regulator.

## Section 8

### Electrical System and Components

#### Troubleshooting Guide

##### 15/25 amp Battery Charging System

When problems occur in keeping the battery charged or the battery charges at too high a rate, the problem can usually be found somewhere in the charging system or with the battery.

NOTE: **Always zero ohmmeter on each scale before testing** to ensure accurate readings. Voltage tests should be made with the engine running at 3600 RPM - no load. The battery must be fully charged.

Problem	Test	Conclusion
<b>No Charge to Battery</b>	<p>1. Trace B+ lead from rectifier-regulator to key switch, or other accessible connection. Disconnect it from switch or connection. Connect an ammeter from loose end of B+ lead to positive terminal of battery. Connect DC voltmeter from loose end of B+ lead to negative terminal of battery. With engine running at 3600 RPM, read voltage on voltmeter.</p> <p>If voltage is 13.8 volts or more, place a minimum load of 5 amps* on battery to reduce voltage. Observe ammeter.</p> <p>*NOTE: Turn on lights, if 60 watts or more. Or place a 2.5 ohm, 100 watt resistor across battery terminals.</p>	<p>1. If voltage is 13.8-14.7 and charge rate increases when load is applied, the charging system is OK and battery was fully charged.</p> <p>If voltage is less than 13.8 or charge rate does not increase when load is applied, test stator (Tests 2 and 3).</p>
	<p>2. Remove connector from rectifier-regulator. With engine running at 3600 RPM, measure AC voltage across stator leads using an AC voltmeter.</p>	<p>2. If voltage is <b>28 volts or more</b>, stator is OK. Rectifier-regulator is faulty. Replace the rectifier-regulator.</p> <p>If voltage is <b>less than 28 volts</b>, stator is probably faulty and should be replaced. Test stator further using an ohmmeter (Test 3).</p>
	<p>3a. With engine stopped, measure the resistance across stator leads using an ohmmeter.</p>	<p>3a. If resistance is <b>.064/0.2 ohms</b>, the stator is OK.</p> <p>If the resistance is <b>infinity ohms</b>, stator is open. Replace stator.</p>
	<p>3b. With the engine stopped, measure the resistance from each stator lead to ground using an ohmmeter.</p>	<p>3b. If the resistance is <b>infinity ohms</b> (no continuity), the stator is OK (not shorted to ground).</p> <p>If resistance (or continuity) is <b>measured</b>, the stator leads are shorted to ground. Replace stator.</p>
<b>Battery Continuously Charges at High Rate</b>	<p>1. Perform same test as step 1 above.</p>	<p>1. If the voltage is <b>14.7 volts or less</b> the charging system is OK. The battery is unable to hold a charge. Service battery or replace as necessary.</p> <p>If voltage is <b>more than 14.7 volts</b>, the rectifier-regulator is faulty. Replace rectifier-regulator.</p>

**Stator**

The stator is mounted on the crankcase behind the flywheel. Should the stator have to be replaced, follow the procedures in Section 9 "Disassembly." See Figure 8-7 for 15 amp stator or Figure 8-8 for 25 amp stator.

**Rectifier-Regulator**

The rectifier-regulator is mounted on the blower housing on standard engines, and on the valley baffle on top tank engines. To replace it, disconnect the plug, remove the two mounting bolts and ground strap.

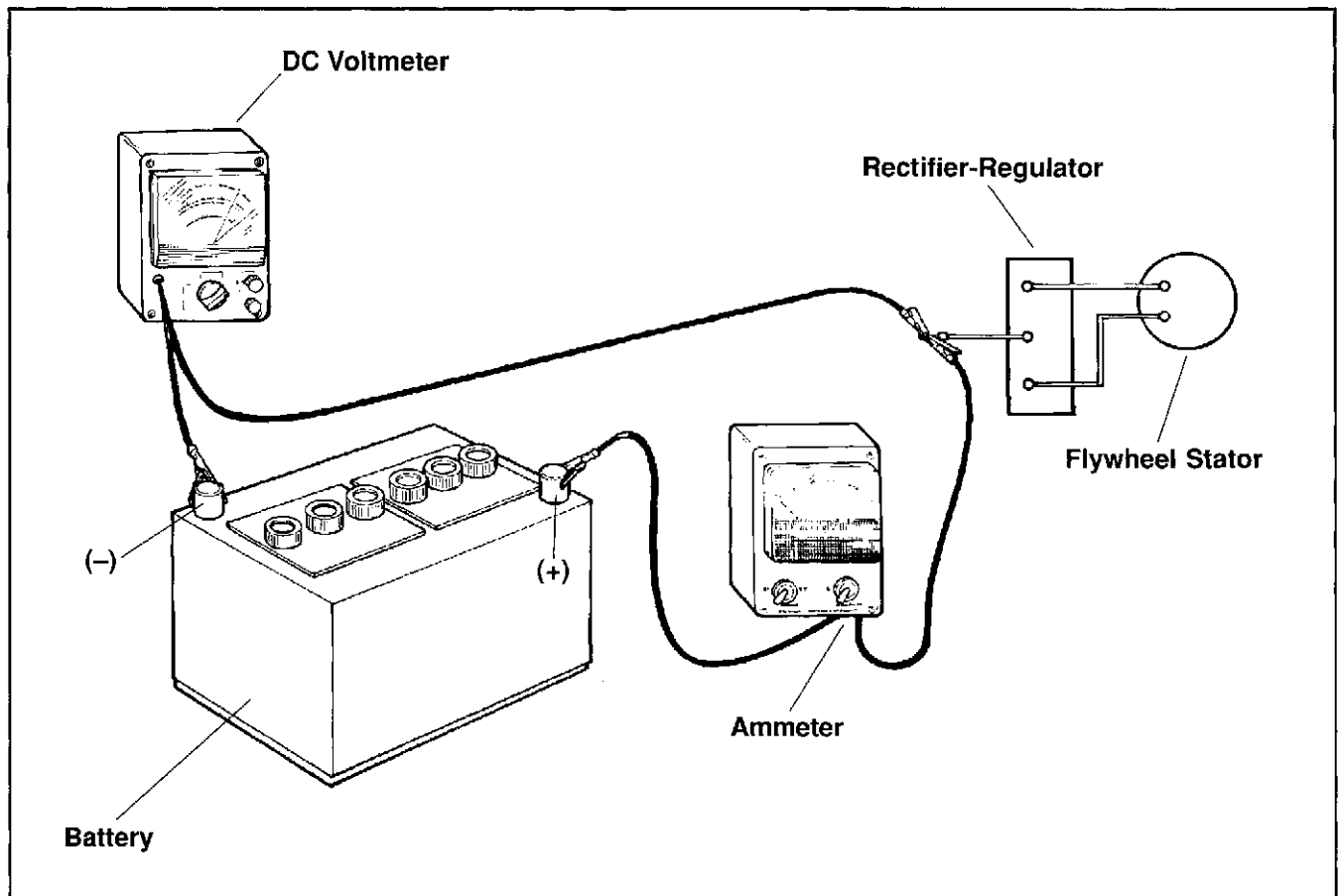


Figure 8-9. Connections for Testing Charging System.



## Section 8

### Electrical System and Components

#### Electric Starting Motors

Some engines in this series use inertia drive type starting motors while others use solenoid shift type. The inertia drive types are covered first and the solenoid shift type is covered starting on page 8.16.

#### Starting Motor Precautions

NOTE: Do not crank the engine continuously for more than 10 seconds at a time. If the engine does not start, allow a 60 second cool-down period between starting attempts. Failure to follow these guidelines can burn out the starter motor.

NOTE: If the engine develops sufficient speed to disengage the inertia drive type starter but does not keep running (a false start), the engine rotation must be allowed to come to a complete stop before attempting to restart the engine. If the starter is engaged while the flywheel is rotating, the starter pinion and flywheel ring gear may clash, resulting in damage to the starter.

NOTE: If the starter does not crank the engine, shut off the starter immediately. Do not make further attempts to start the engine until the condition is corrected.

NOTE: Do not drop the starter or strike the starter frame. Doing so can damage the starter.

#### Starter Removal and Installation

Refer to the "Disassembly" and "Reassembly" Sections for starter removal and installation procedures.

#### Inertia Drive Electric Starters

This subsection covers the operation, troubleshooting, and repair of the inertia drive permanent magnet electric starters from United Technologies (UT).

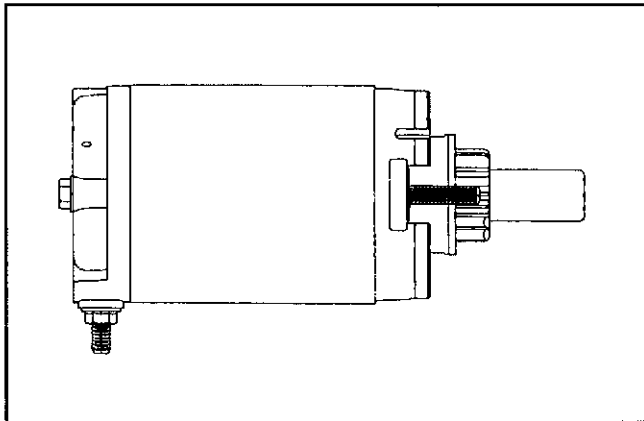
#### Troubleshooting Guide - Starting Difficulties

Problem	Possible Fault	Correction
<b>Starter Does Not Energize</b>	<b>Battery</b>	1. Check the specific gravity of battery. If low, recharge or replace battery as necessary.
	<b>Wiring</b>	1. Clean corroded connections and tighten loose connections. 2. Replace wires in poor condition and with frayed or broken insulation.
	<b>Starter Switch or Solenoid</b>	1. Bypass the switch or solenoid with a jumper wire. If starter cranks normally, replace the faulty components.
<b>Starter Energizes But Turns Slowly</b>	<b>Battery</b>	1. Check the specific gravity of battery. If low, recharge or replace battery as necessary. 2. Battery too small, must be at least 250 cold-cranking amps.
	<b>Brushes</b>	1. Check for excessively dirty or worn brushes and commutator. Clean using a coarse cloth (not emery cloth). 2. Replace brushes if excessively or unevenly worn.
	<b>Transmission or Engine</b>	1. Make sure the clutch or transmission is disengaged or placed in neutral. This is especially important on equipment with hydrostatic drive. The transmission must be exactly in neutral to prevent resistance which could keep the engine from starting. 2. Check for seized engine components such as the bearings, connecting rod, and piston.

**Operation - Inertia Drive Starters**

When power is applied to the starter, the armature rotates. As the armature rotates, the drive pinion moves out on the splined drive shaft and into mesh with the flywheel ring gear. When the pinion reaches the end of the drive shaft, it rotates the flywheel and "cranks" the engine.

When the engine starts, the flywheel rotates faster than the starter armature and drive pinion. This moves the drive pinion out of mesh with the ring gear and into the retracted position. When power is removed from the starter, the armature stops rotating and the drive pinion is held in the retracted position by the anti-drift spring.



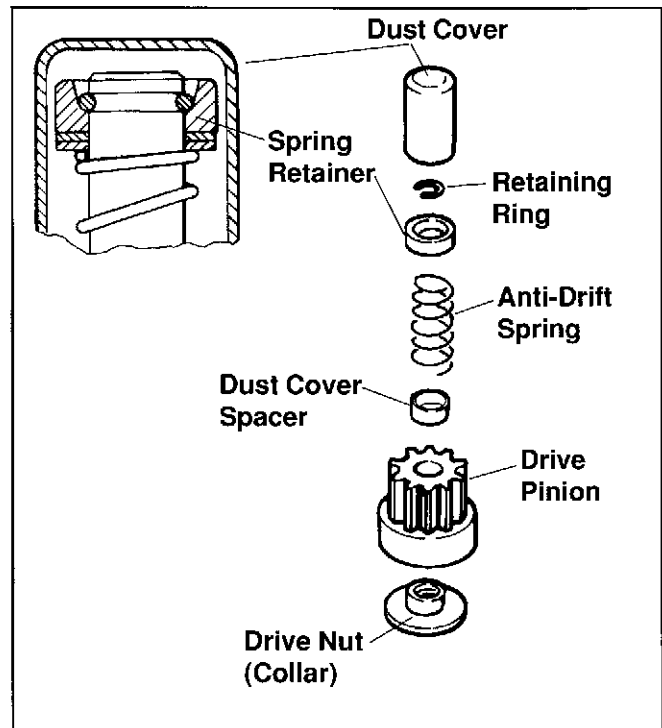
**Figure 8-10. UT Inertia Drive Electric Starter.**

**UT Starter Drive Service**

Every **500 hours** of operation (or annually, whichever occurs first), clean and lubricate the splines on the starter drive shaft. If the drive pinion is worn, or has chipped or broken teeth, it must be replaced.

It is not necessary to completely disassemble the starter to service the drive components, but it is necessary to remove the starter from the engine. Tape the commutator end cap to the starter frame, so they cannot separate when the bolts are loosened for removal. Remove the starter.

Service the drive as follows:



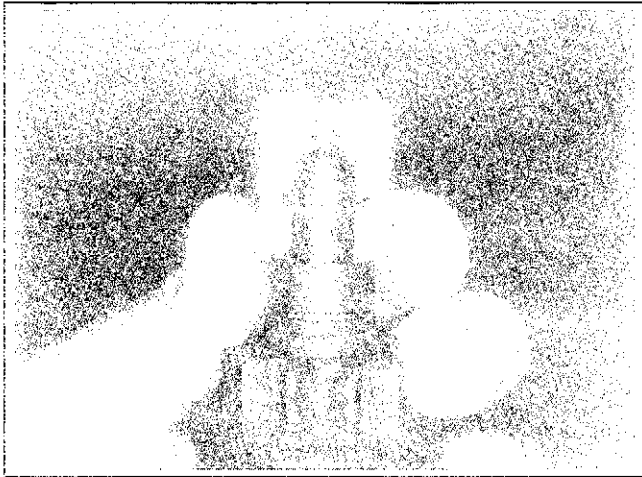
**Figure 8-11. Drive Components, UTE "Bonded" Inertia Drive Starter.**

1. The rubber dust cover has a molded lip on the inside that snaps into a groove in the dust cover spacer (See Figure 8-11). Turn the drive pinion clockwise until it reaches the fully extended position. While holding it in the extended position, grasp the tip of the dust cover with a pliers or vise grip and pull it free from the spacer.
2. Disassemble removal tool, 25 761 18, by loosening the center screw one or two turns and removing the outer collar.
3. Again referring to Figure 8-11, grasp the spring retainer and push it toward the starter, compressing the anti-drift spring and exposing the retaining ring.

## Section 8

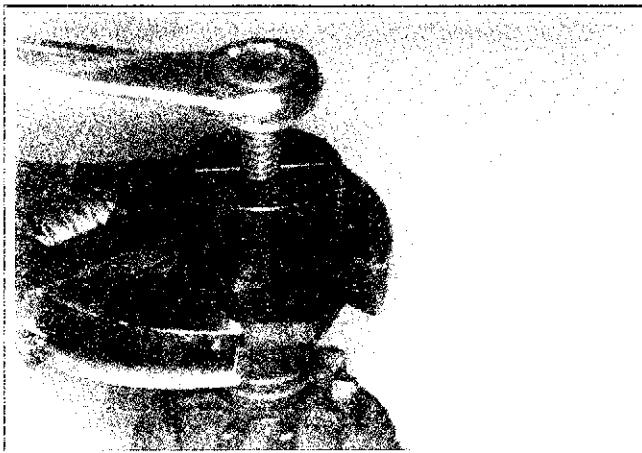
### Electrical System and Components

4. Holding the spring retainer in the retracted position, assemble the inner halves of the removal tool around the armature shaft with the retaining ring in the inner groove (see Figure 8-12). Slide the collar over the inner halves to hold them in position.



**Figure 8-12. Assembling Inner Half of Tool Around Armature Shaft and Retaining Ring.**

5. Thread the center screw into the removal tool until you feel resistance. Use a wrench (1-1/8" or adjustable) to hold the base of the removal tool. Use another wrench or socket (1/2" or 13 mm) to turn the center screw clockwise (see Figure 8-13). The resistance against the center screw will tell you when the retaining ring has popped out of the groove in the armature shaft.



**Figure 8-13. Holding Tool and Turning Center Screw (Clockwise) to Remove Retaining Ring.**

6. Remove the drive components from the armature shaft, paying attention to the sequence. If the splines are dirty, clean them with solvent.

7. The splines should have a light film of lubricant. Relubricate as necessary with Kohler bendix starter lubricant (Part No. 52 357 01). Reinstall or replace the drive components, assembling them in the same sequence as they were removed.

#### Retaining Ring Installation

1. Position the retaining ring in the groove in one of the inner halves of tool 25 761 18. Assemble the other half over the top and slide on the outer collar.
2. Be certain the drive components are installed in correct sequence onto the armature shaft.
3. Slip the tool over the end of the armature shaft, so the retaining ring inside is resting on the end of the shaft. Hold the tool with one hand, exerting slight pressure toward the starter. Tap the top of the tool with a hammer until you feel the retaining ring snap into the groove. Disassemble and remove the tool.
4. Assemble the inner halves with the larger cavity around the spring retainer (see Figure 8-14). Slide the collar over them and thread the center screw in until resistance is felt.



**Figure 8-14. Assembling Larger Inner Half Around Spring Retainer.**

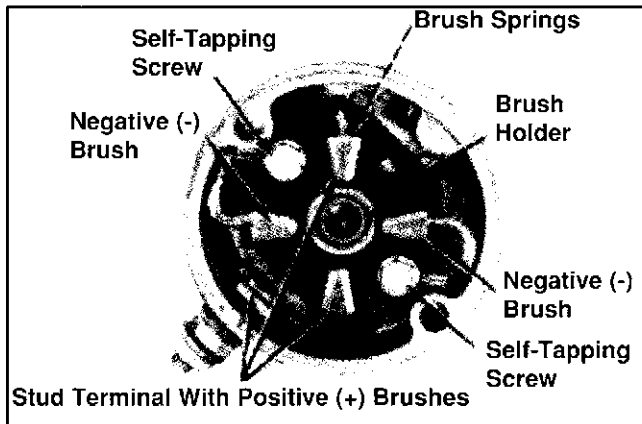
5. Hold the base of the tool with a 1-1/8" wrench and turn the center screw clockwise with a 1/2" or 13 mm wrench to draw the spring retainer up around the retaining ring. Stop turning when resistance increases. Disassemble and remove tool.
6. Reinstall the dust cover.

#### UT Starter Disassembly

1. Remove the dust cover, retainer ring, spring retainer, anti-drift spring, dust cover spacer, and drive pinion. Refer to "UT Starter Drive Service" starting on page 8.13.
2. Remove the thru bolts.
3. Remove the commutator end cap with brushes and brush springs.
4. Remove the drive end cap.
5. Remove the armature and thrust washer from inside the starter frame.

#### UT Brush Replacement

1. Remove the brush springs from the pockets in brush holder. See Figure 8-15.



**Figure 8-15. Commutator End Cap with Brushes.**

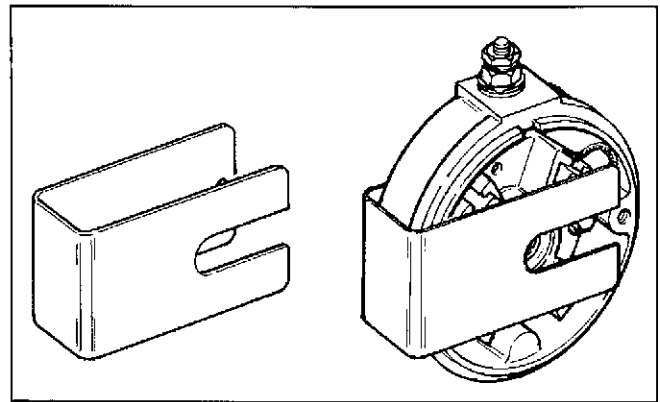
2. Remove the self-tapping screws, negative (-) brushes, and plastic brush holder.
3. Remove the hex. flange nut and fiber washer from the stud terminal.

Remove the stud terminal with positive (+) brushes and plastic insulating bushing from the end cap.

4. Reinstall the insulating bushing to the new stud terminal with positive (+) brushes. Install the stud terminal with bushing into the commutator end cap. Secure the stud with the fiber washer and hex. flange screw.

5. Install the brush holder, new negative (-) brushes, and self-tapping screws.
6. Install the brush springs and brushes into the pockets in brush holder. Make sure the chamfered sides of brushes are away from the brush springs.

**NOTE:** Use a brush holder tool to keep the brushes in the pockets. A brush holder tool can easily be made from thin sheet metal. See Figure 8-16.



**Figure 8-16. Brush Holder Tool (For UT Starters).**

#### UT Commutator Service

Clean the commutator with a coarse, lint free cloth. Do not use emery cloth.

If the commutator is badly worn or grooved, turn it down on a lathe or replace the armature.

#### UT Starter Reassembly

1. Place the thrust washer over the drive shaft of armature.
2. Insert the armature into the starter frame. Make sure the magnets are closer to the drive shaft end of armature. The magnets will hold the armature inside the frame.

## Section 8 Electrical System and Components

3. Install the drive end cap over the drive shaft. Make sure the match marks on the end cap and starter frame are aligned. See Figure 8-17. The small notch in the edge of the end cap, adjacent to the match mark, will engage a small tang inside the end of the starter frame.

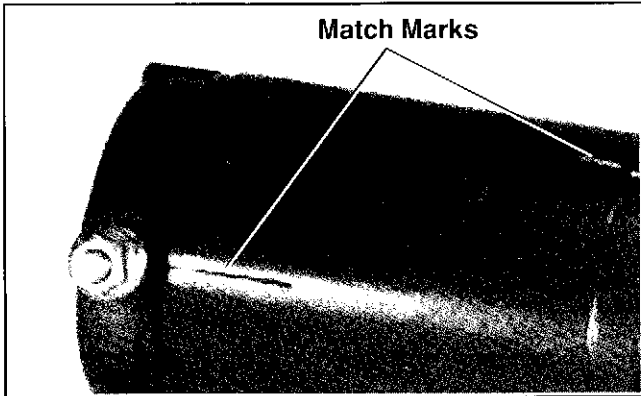


Figure 8-17. UT Starter Assembly Match Marks.

4. Install the brush holder tool to keep the brushes in the pockets of the commutator end cap.
5. Align the terminal stud on the commutator end cap with the long scribe mark on the starter frame. Hold the drive end and commutator end caps firmly to the starter frame. Remove the brush holder tool.

6. Install the thru bolts and tighten securely.
7. Lubricate the drive shaft with Kohler electric starter drive lubricant. Install the drive pinion, dust cover spacer, anti-drift spring, spring retainer, retaining ring, and dust cover. Refer to "UT Starter Drive Service" on page 8.13.

### Solenoid Shift Electric Starter

This subsection covers the solenoid shift electric starter. Much of the information in the preceding subsection relates to this starter, therefore it is not repeated here. Please use the exploded view (Figure 8-18) for reference during the disassembly and assembly procedure.

### Operation

When power is applied to the starter, the electric solenoid moves the drive pinion out onto the drive shaft and into mesh with the flywheel ring gear. When the pinion reaches the end of the drive shaft it rotates the flywheel and cranks the engine.

When the engine starts and the start switch is released the starter solenoid is deactivated, the drive lever moves back, and the drive pinion moves out of mesh with the ring gear into the retracted position.

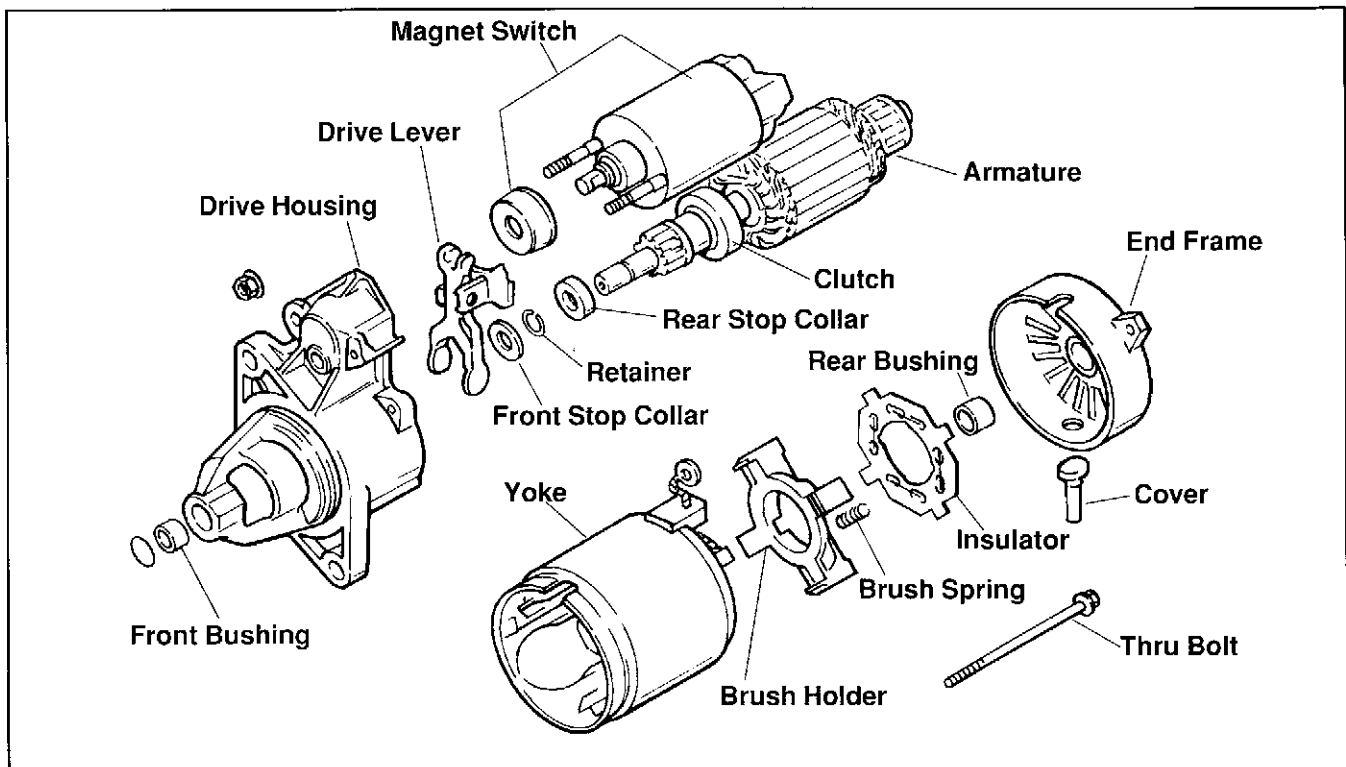


Figure 8-18. Exploded View of Solenoid Shift Starter.

### Starter Removal and Reinstallation

Refer to the engine disassembly and reassembly sections later in this manual for starter removal and installation procedures.

### Starter Disassembly

1. Disconnect the wire from the solenoid.
2. Remove the hex. nuts securing the solenoid, and remove the solenoid from the starter assembly.
3. Remove the two thru bolts.
4. Remove the commutator end cap.
5. Remove the insulator and brush springs from the brush spring holder.

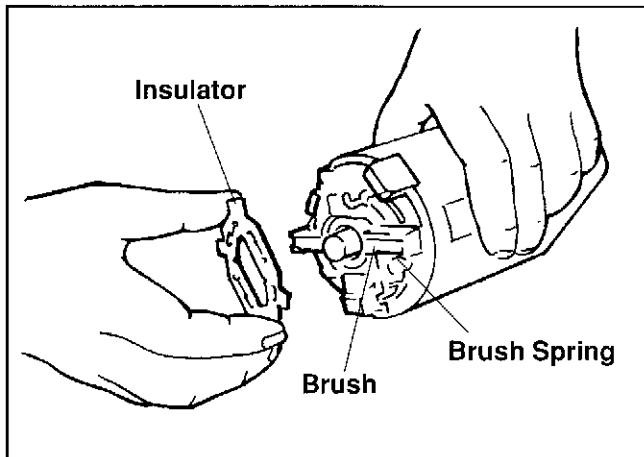


Figure 8-19. Removing the Insulator.

6. Remove the armature from the frame.
7. Remove the drive lever and armature from the drive end cap.

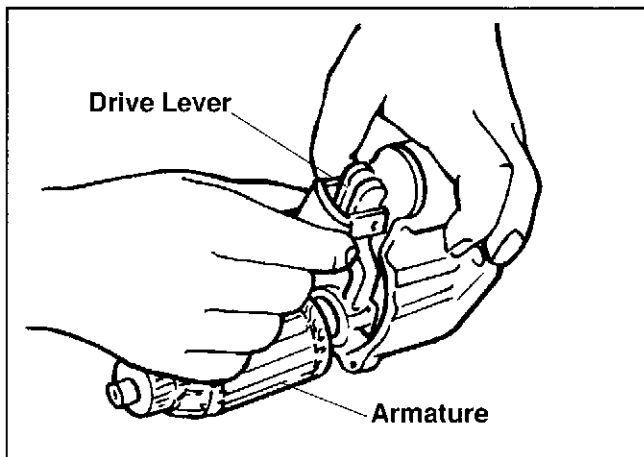


Figure 8-20. Removing the Armature and Drive Lever.

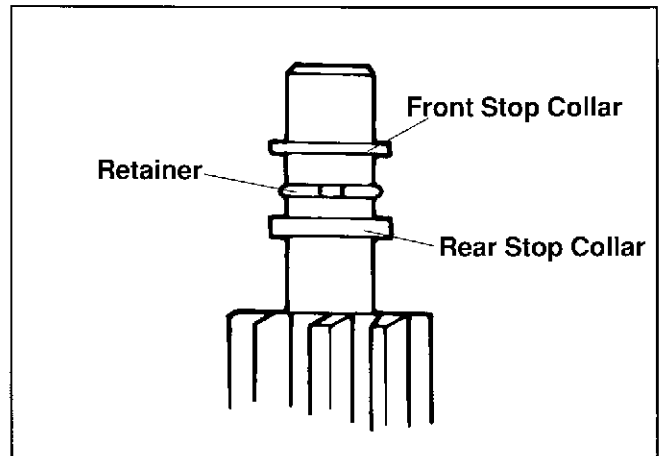


Figure 8-21. Stop Collars and Retainer.

8. The stop collar consists of two pieces. The rear stop collar is held in place by being snapped over a retainer. The retainer is held in place by a groove in the armature shaft. The front stop collar rests against the rear stop collar. Slide the front stop collar off of the armature shaft. See Figure 8-22. Use a 1/2" or 13 mm deep socket and plastic hammer and tap the rear stop collar down to separate it from the retainer. See Figure 8-23.

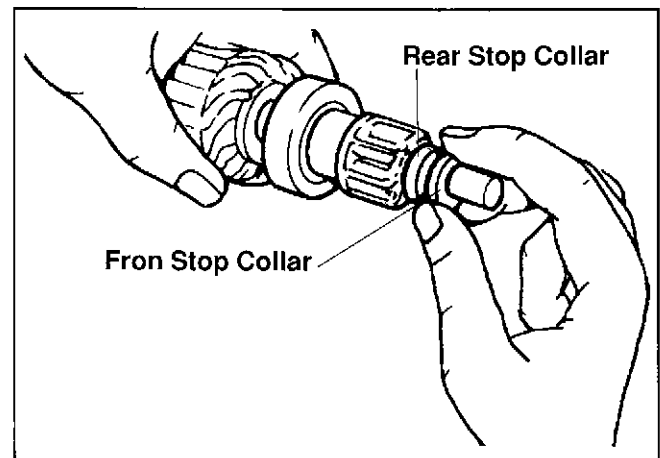
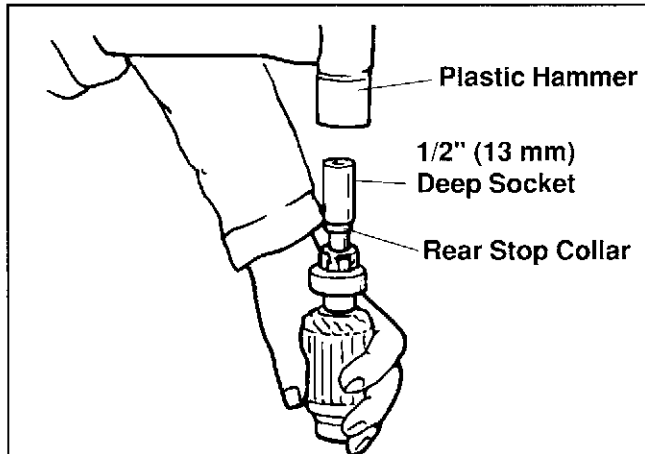


Figure 8-22. Removing the Front Stop Collar.

## Section 8 Electrical System and Components

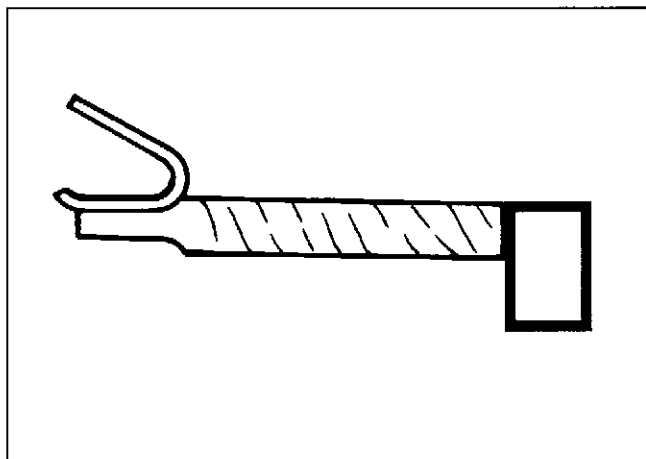


**Figure 8-23. Separating the Rear Stop Collar From the Retainer.**

9. After the stop collars are removed, the retainer can be removed from the armature shaft. Do not reuse the retainer.

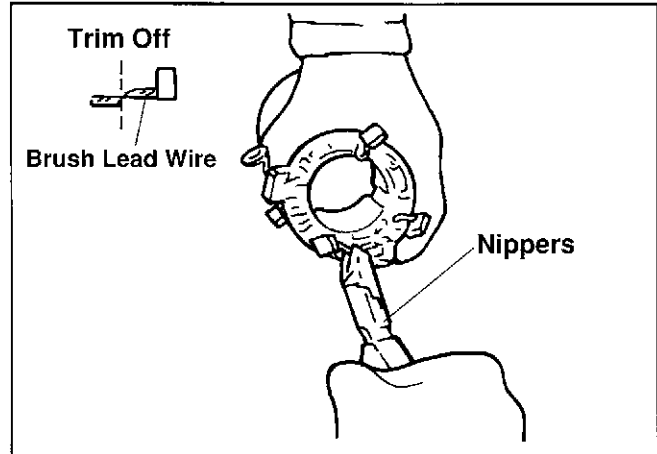
### Brush Replacement

The brushes in the starter are part of the starter frame, brush kit Part No. 52 221 01 contains four replacement brushes and springs. If replacement is necessary, all four brushes should be replaced.



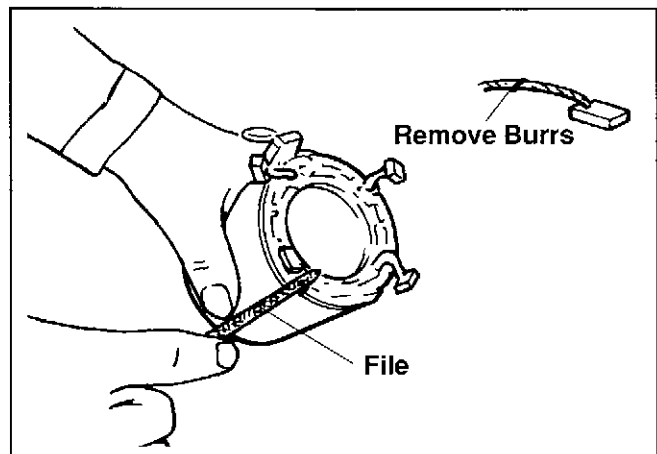
**Figure 8-24. Replacement Brush.**

1. Remove brushes from brush holder, and remove brush holder from frame.



**Figure 8-25. Cutting Brush Lead Wires From the Frame Posts.**

2. Cut the brush lead wire at the edge of the post with a pair of nippers.
3. File off burrs on the post.



**Figure 8-26. Filing Off Burrs on Posts.**

4. Place the plate of the spare brush on the welded portion of the brush lead wire, and then crimp them together with a pair of pliers. Be sure to align the edge of the lead wire.

## Section 8 Electrical System and Components

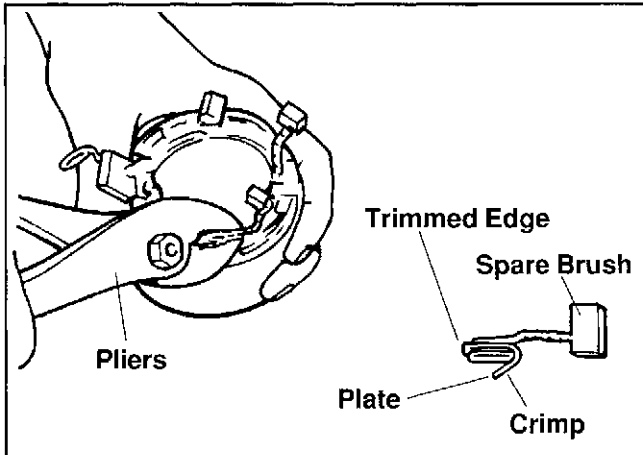


Figure 8-27. Connecting Replacement Brushes.

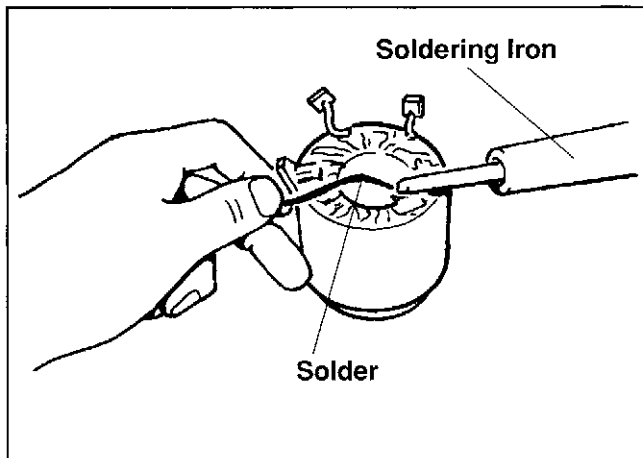


Figure 8-28. Soldering Brush Clips To Posts.

5. Solder the crimped portion to the post.
6. Replace the brush holder in the frame and place the brushes in the brush holder. Reinstall the springs.

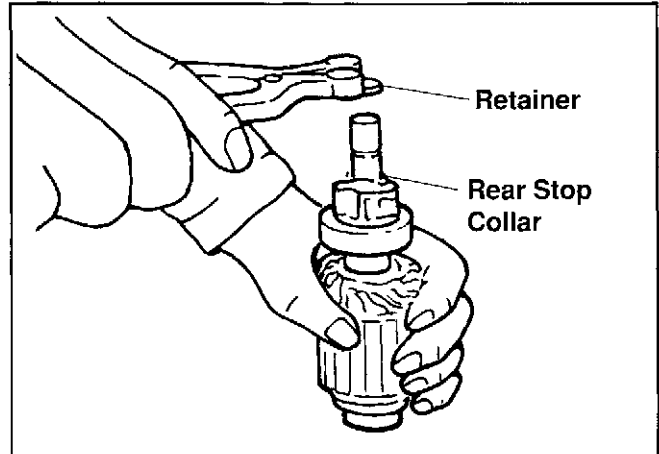


Figure 8-29. Installing Retainer.

### Starter Service

Clean drive lever and armature shaft; then apply Kohler electric starter drive lubricant or equivalent to lever and shaft.

### Starter Reassembly

1. Insert the rear stop collar on the armature shaft.



## Section 8 Electrical System and Components

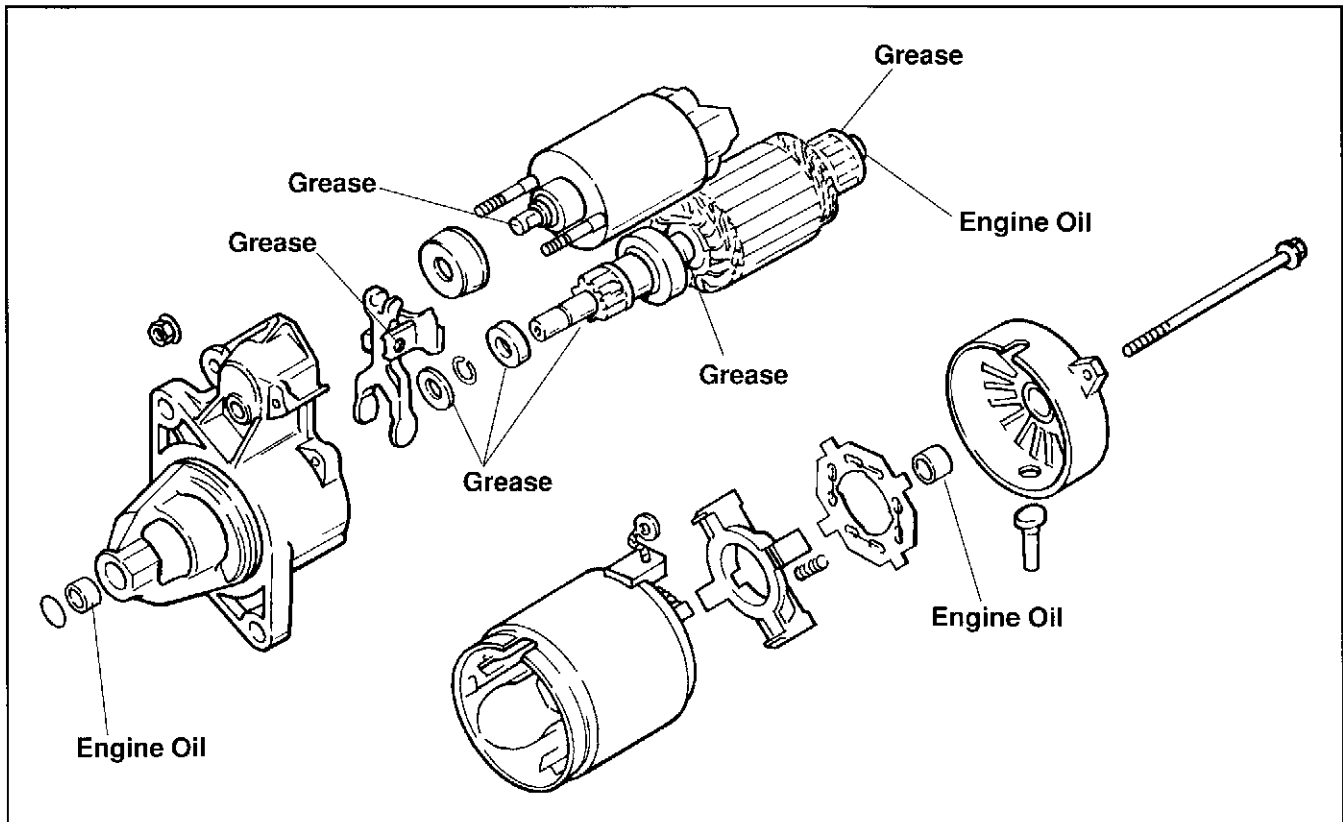


Figure 8-30. Lubrication Points.

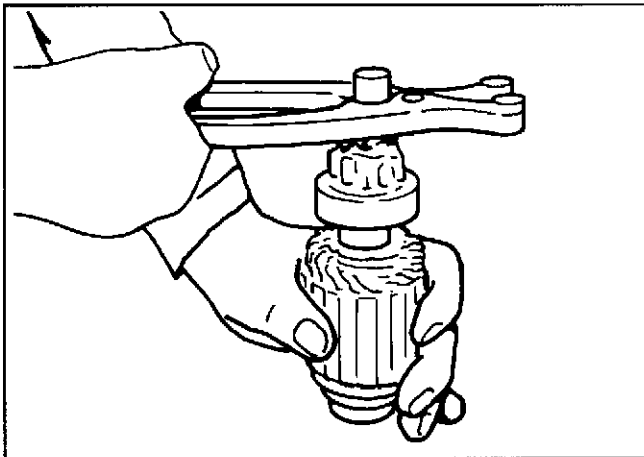


Figure 8-31. Tightening the Retainer.

2. Install new retainer in the groove on the armature shaft.

NOTE: Always use a new retainer. Tighten the retainer in the groove to secure.

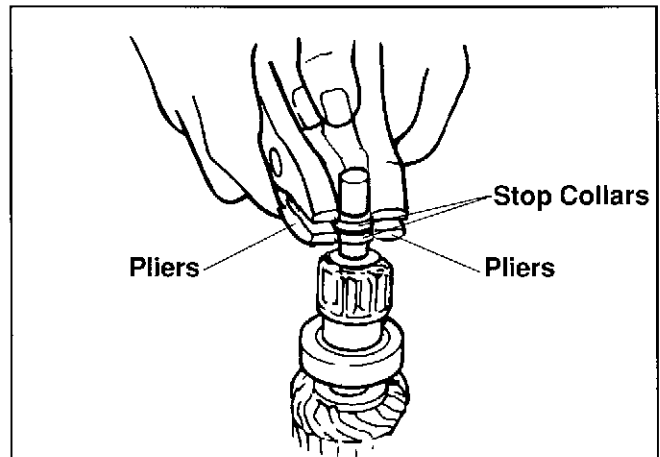
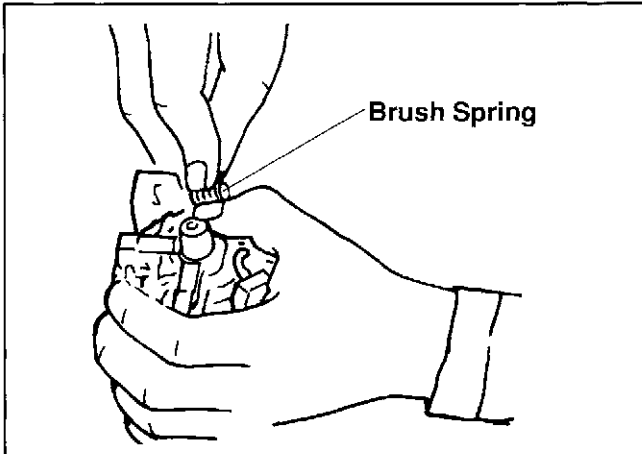


Figure 8-32. Installing the Stop Collar.

3. Fit the front stop collar over the shaft and bring the front and the rear stop collars together over the retainer. Using two pairs of pliers, apply even force to the two collars until they snap over the retainer and nest into one another.



**Figure 8-33. Installing the Brush Springs.**

4. Reassemble the remaining components of the starter in reverse order of disassembly.

## Section 9

# Disassembly



### **WARNING: Accidental Starts!**

*Before servicing the engine or equipment, always disconnect the spark plug lead(s) to prevent the engine from starting accidentally. Ground the leads to prevent sparks that could cause fires. Make sure the equipment is in neutral.*

### **General**

Clean all parts thoroughly as the engine is disassembled. Only clean parts can be accurately inspected and gauged for wear or damage. There are many commercially available cleaners that will quickly remove grease, oil and grime from engine parts. When such a cleaner is used, follow the manufacturer's instructions and safety precautions carefully.

Make sure all traces of the cleaner are removed before the engine is reassembled and placed into operation. Even small amounts of these cleaners can quickly break down the lubricating properties of engine oil.

### **Typical Disassembly Sequence**

The following sequence is suggested for complete engine disassembly. The sequence can be varied to accommodate options or special equipment.

1. Disconnect spark plug leads.
2. Turn fuel shut-off valve to "off" position.
3. Drain oil from crankcase and remove oil filter.
4. Remove air cleaner assembly.
5. Remove fuel tank (if so equipped).
6. Remove muffler (if so equipped).
7. Disconnect carburetor linkage.
8. Remove retractable starter or grass screen.
9. Remove blower housing.
10. Remove electric starter motor.
11. Remove side baffles.
12. Remove ignition modules.
13. Remove flywheel.
14. Remove stator.
15. Remove timing belt.
16. Remove valve covers.
17. Remove #1 side camshaft.
18. Remove rocker arms.
19. Remove #2 side camshaft.
20. Remove governor yoke.
21. Remove rectifier-regulator.
22. Remove valley baffle.
23. Remove crankcase breather.
24. Remove Oil Sentry™ Switch.
25. Remove oil filter adapter.
26. Separate crankcase halves.
27. Remove oil pump parts.
28. Remove oil pressure relief parts.
29. Remove connecting rods.
30. Remove crankshaft.
31. Disassemble crankshaft.
32. Remove piston assemblies.
33. Remove valve train parts.

### **Disconnect Spark Plug Leads**

1. Disconnect the leads from the spark plugs. See Figure 9-1.

**NOTE:** Pull on boot only, to prevent damage to spark plug lead.



**Figure 9-1. Disconnect Both Spark Plug Leads.**

## Section 9 Disassembly

### Turn Fuel Off

1. Turn fuel shut-off valve to **off** position. Vertical position is off. See Figure 9-2.

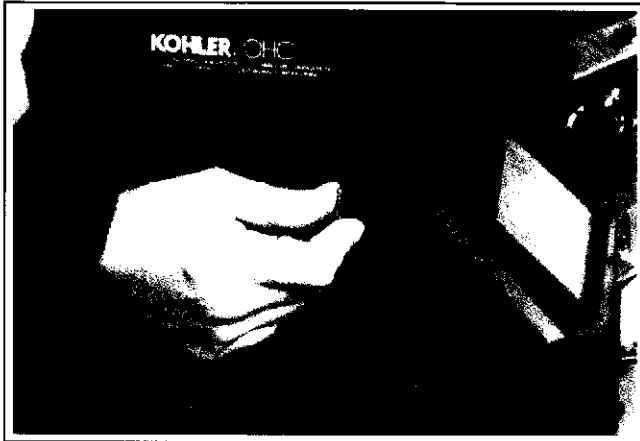


Figure 9-2. Turn Fuel Off.

### Drain Oil From Crankcase and Remove Oil Filter

1. Remove oil fill cap and one of the oil drain plugs. See Figure 9-3 for location of drain on oil filter side.

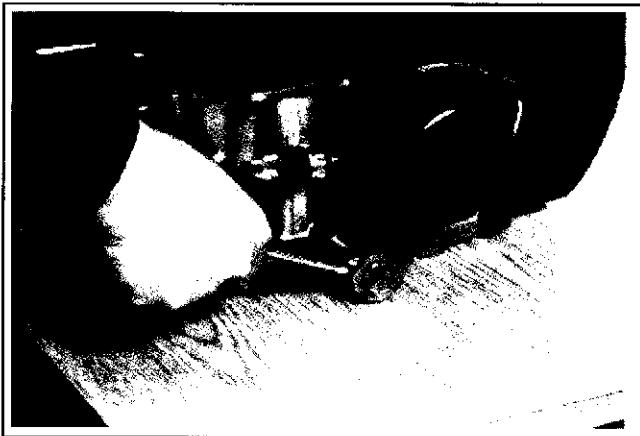


Figure 9-3. Removing Oil Drain Plug and Filter.

2. Allow ample time for all of the oil to drain from the crankcase and oil filter.
3. Remove the oil filter by turning it in a counterclockwise direction with a filter wrench. Discard filter.

### Remove Air Cleaner Assembly

1. Remove air cleaner components from base plate. Refer to Section 4.

2. Remove the air cleaner base from carburetor elbow by removing the three hex. flange screws. See Figure 9-4. Remove the base plate. Some early engines may also have a spacer between the base plate and elbow.

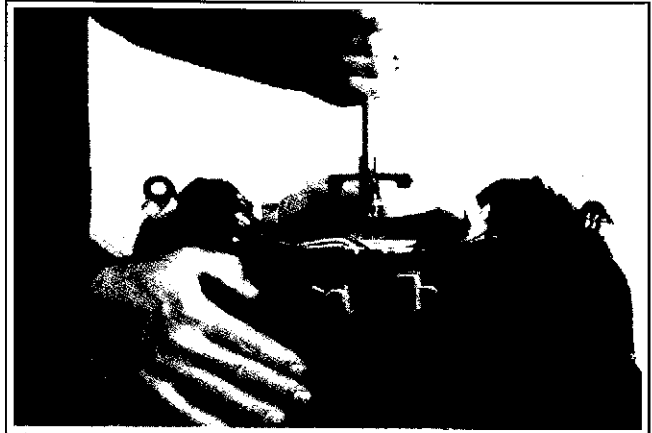


Figure 9-4. Removing Base Plate (Standard Type Shown).

3. Discard the base plate to carburetor gasket.

### Remove Fuel Tank (If So Equipped)

1. On engines equipped with the top-mounted fuel tank, remove the five hex. flange screws securing the tank to the valve covers.
2. Lift the tank and pull it forward. Fuel line will come with it. See Figure 9-5.

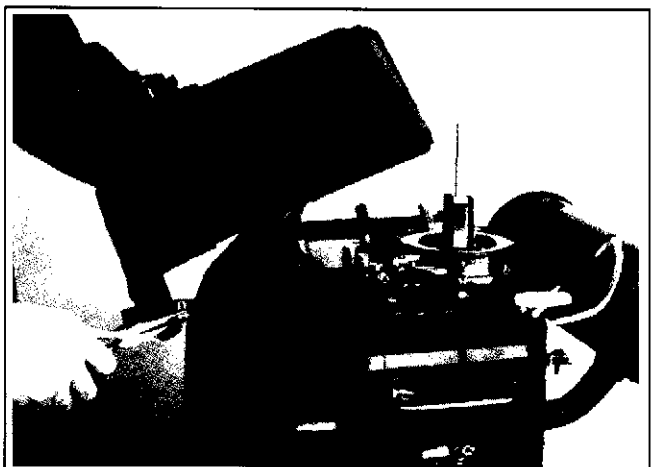


Figure 9-5. Removing Engine-Mounted Fuel Tank.

3. Loosen hose clamp holding fuel line to the fuel shut-off valve, then separate hose and remove fuel tank.

### Remove Muffler

1. On engine so equipped, remove the muffler from engine by removing the four hex. flange nuts (2 on each side) with a 13 mm flex socket. See Figure 9-6.



Figure 9-6. Removing Muffler.

2. Remove and discard the two exhaust gaskets.

### Disconnect Carburetor Linkage

1. Loosen the hose clamp holding the upper end of the breather hose on the flange of the carburetor elbow. Pull the end off the flange. See Figure 9-7.

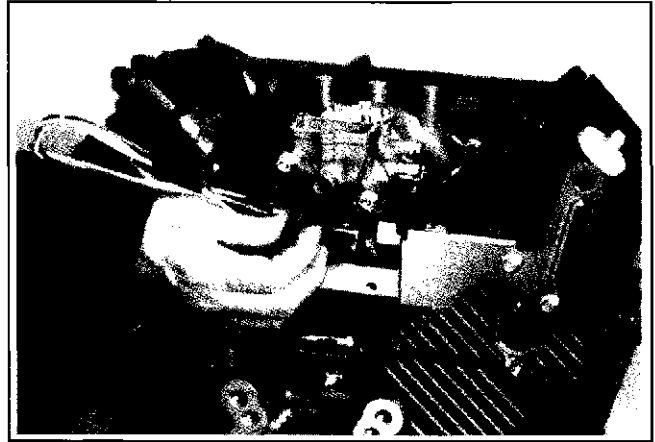


Figure 9-7. Disconnecting Breather Hose.

2. Carefully disconnect the flanged lower end of the hose from the breather cover. Remove the hose.
3. Loosen the hex. flange nut and slide the governor lever off of the governor shaft.

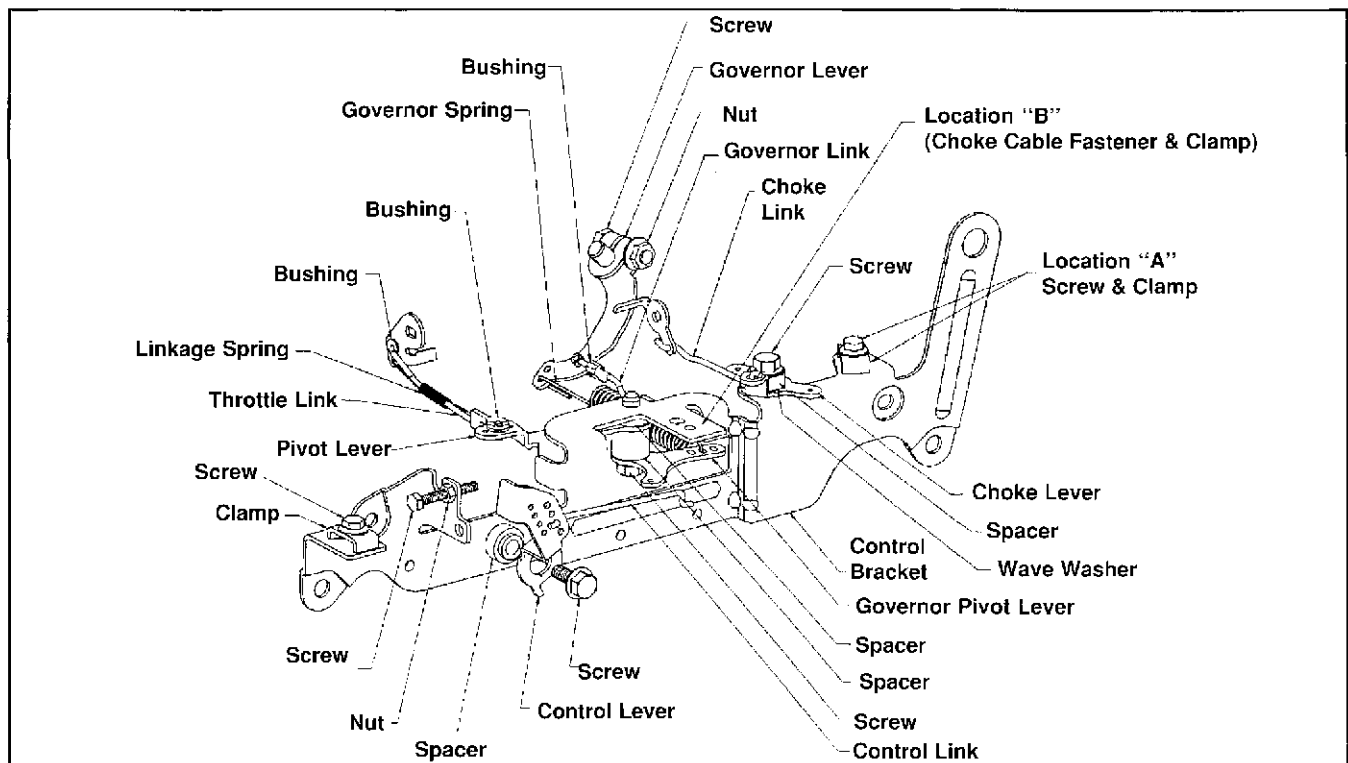


Figure 9-8. Standard Throttle Control Detail.

## Section 9

### Disassembly

---

4. Disconnect the fuel line from the carburetor by using a needle nose pliers to loosen the hose clamp.
5. Remove the two hex. flange nuts from the carburetor mounting studs. On engines without a top tank, thread the carburetor nuts, flanges facing, onto the stud protruding from the top of the crankcase. "Jam" them together and then turn the lower one counterclockwise to remove the stud.
6. Slide the intake elbow, carburetor, and spacer off the mounting studs on the intake manifold. Lift the carburetor and control bracket assembly and disconnect the leads from the fuel shut-off solenoid.
7. Remove the carburetor, control bracket, governor lever, and attached linkages as an assembly. If further service of the components is necessary, the assembly can be broken down following steps 8-11.
8. Unsnap the linkage bushing and disconnect the throttle link and linkage spring from the pivot lever. See Figure 9-8.
9. Disconnect choke link from carburetor and choke lever.
10. Unsnap the bushing and disconnect the governor link from the pivot lever.
11. Mark the hole position of the governor spring in the governor lever and governor pivot lever. Remove the spring.

#### Remove Retractable Starter or Grass Screen

1. On engines so equipped, remove the retractable starter from blower housing by removing the five mounting screws. Note the position of the starter handle to reinstall it later. See Figure 9-9.



Figure 9-9. Remove Retractable Starter.

2. On engines with a grass screen, either unsnap the screen or remove the screws holding it to the flywheel fan.

#### Remove Blower Housing

1. If the rectifier-regulator is mounted to the blower housing, remove the left screw to disconnect the ground lead. Remove the blower housing by removing the six hex. flange screws and two hex. flange nuts (in recesses at top front of housing). Make note of location of the two shorter screws. See Figure 9-10.

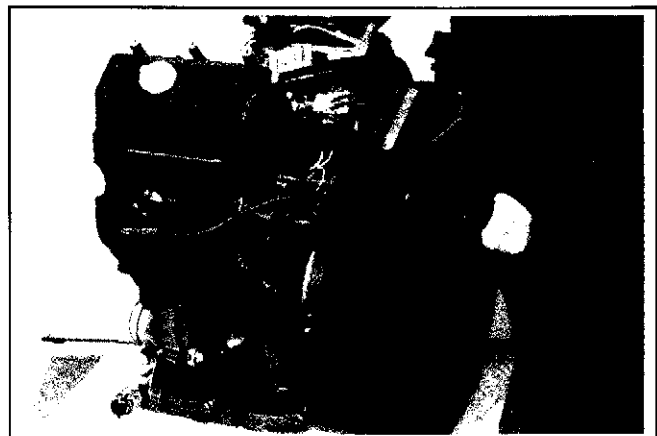


Figure 9-10. Removing Blower Housing.

### Remove Electric Starter

1. If the engine is equipped with a cranking solenoid, disconnect all leads, remove the two hex. flange mounting screws, and remove the solenoid. See Figure 9-11.

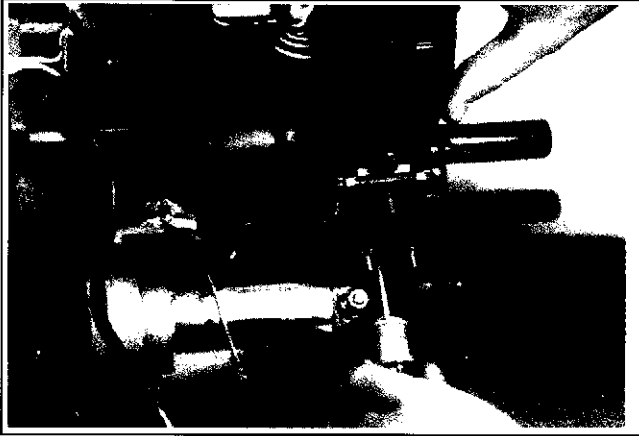


Figure 9-11. Removing Solenoid.

2. The starter thru bolts are also the mounting bolts. Tape the end caps to the frame to prevent them from separating when the bolts are loosened.
3. Remove the top 3/8" mounting screw as shown in Figure 9-12.

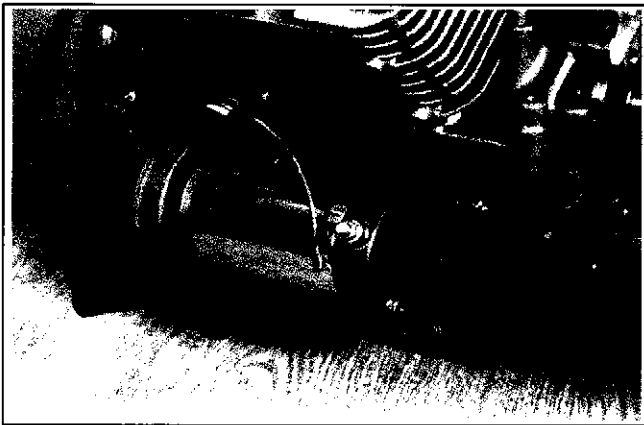


Figure 9-12. Removing Starting Motor.

4. Loosen the bottom 3/8" mounting screw just enough to remove the starting motor. Do not completely remove the mounting screw from starter.

### Remove Side Baffles

1. Remove the single screw holding the side baffle to the #2 cylinder and remove the baffle. See Figure 9-13.



Figure 9-13. Removing #2 Side Baffle.

2. To remove the #1 side baffle, loosen the two screws holding the wire connector and slide the connector off.
3. Remove the side baffle from the #1 cylinder. See Figure 9-14.



Figure 9-14. Removing #1 Side Baffle.

### Remove Ignition Modules

1. Turn the flywheel magnet away from the ignition modules.
2. Disconnect the white "kill" leads.

## Section 9 Disassembly

3. Remove the two hex. flange mounting screws from each module and remove both modules. See Figure 9-15.

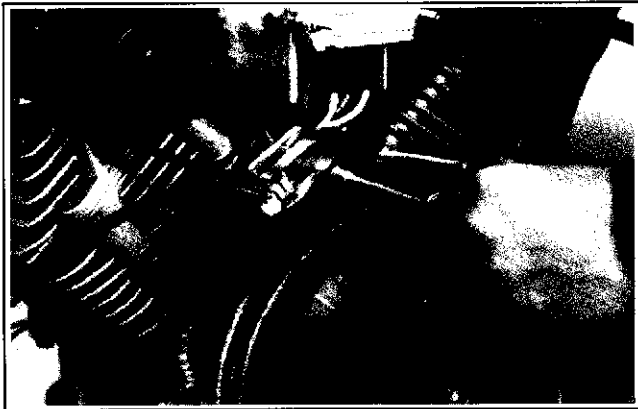


Figure 9-15. Removing Ignition Modules (#1 Side Shown).

### Remove Flywheel

NOTE: Always use a flywheel strap wrench or holding tool to hold the flywheel when loosening or tightening the flywheel screw. Do not use any type of bar or wedge to hold the flywheel. Use of such tools could cause the flywheel to become cracked or damaged.

1. Hold flywheel with a strap wrench or holding tool (refer to Section 2). Turn flywheel retaining screw (13 mm socket) counterclockwise to remove screw and washer. Engines with retractable starters will also have the drive cup retained with the flywheel screw. See Figure 9-16

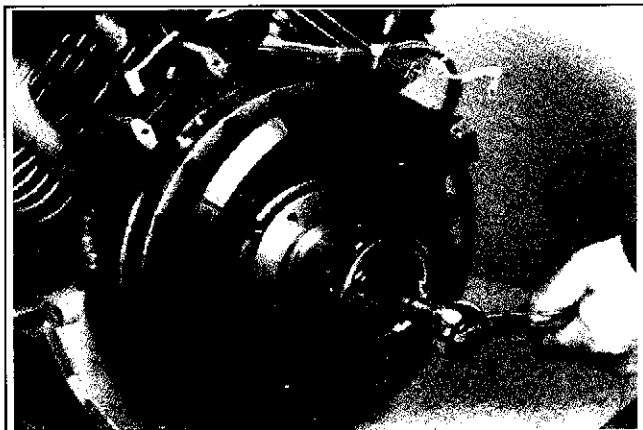


Figure 9-16. Remove Cup From Retractable Starter Equipped Models.

2. Use a flywheel puller to separate flywheel from crankshaft taper. See Figure 9-17.

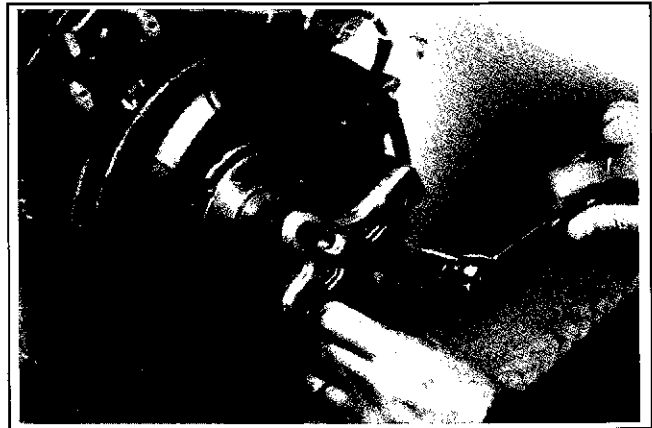


Figure 9-17. Using Puller to Remove Flywheel.

NOTE: Tension spring located inside will "POP" flywheel free of crankshaft. See Figure 9-18.



Figure 9-18. Spring Inside Will "POP" Flywheel Off.

3. Use needle nose pliers or side cutter to grasp and remove flywheel key. See Figure 9-19.

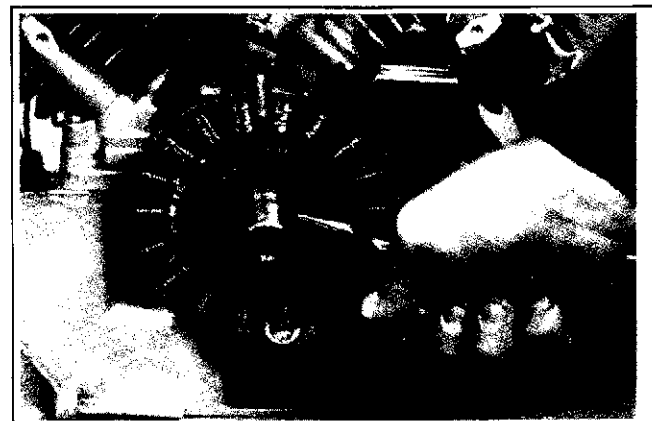


Figure 9-19. Removing Flywheel Key From Crankshaft.



### Remove Stator

1. Note routing of all wiring and harnesses to reassemble in same position later.
2. Remove the two hex. flange screws securing stator to crankcase. See Figure 9-20.



Figure 9-20. Removing Stator.

3. Remove the stator and let it hang loose.

### Remove Timing Belt

1. Remove the two hex. flange screws securing the idler pulley to the crankcase.
2. Remove idler pulley and the timing belt. See Figure 9-21.



Figure 9-21. Remove Idler Pulley to Remove Timing Belt.

### Remove Valve Covers

1. On engines with top-mounted fuel tank, remove the five 7/16" adapter studs and the five hex. flange screws securing covers.

2. On all other engines remove the ten hex. flange screws securing covers.
3. Remove the dipstick.
4. Remove the valve covers and gaskets on both sides. Discard the gaskets. See Figures 9-22, 9-23, and 9-24.



Figure 9-22. Removing #2 Side Valve Cover Studs.



Figure 9-23. Removing #2 Side Valve Cover Screws.



Figure 9-24. Removing Cover and Fuel Pump Assembly (#1 Side).

## Section 9 Disassembly

### Remove #1 Side Camshaft and Rocker Arms

1. Turn the camshaft until tension is off the rocker arms.
2. Remove the "C" clip on inside of rocker box using two small screwdrivers.
3. Remove the camshaft and thrust washer. See Figure 9-25.



Figure 9-25. Removing Camshaft on #1 Side.

4. Remove the two hex. flange screws from the rocker arm shaft. See Figure 9-26.

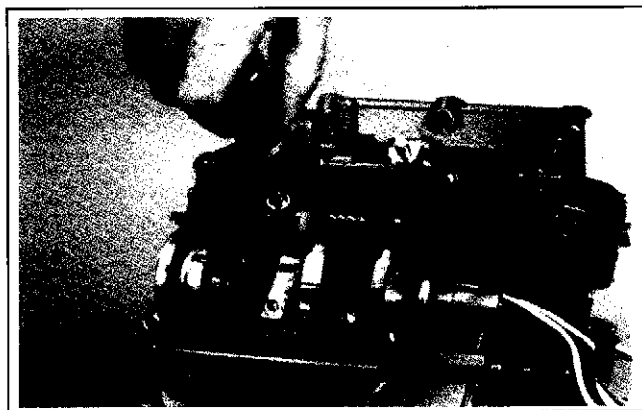


Figure 9-26. Removing Rocker Arm Shaft Screws.

5. Lift rocker arm assembly off valve mechanism. See Figure 9-27.

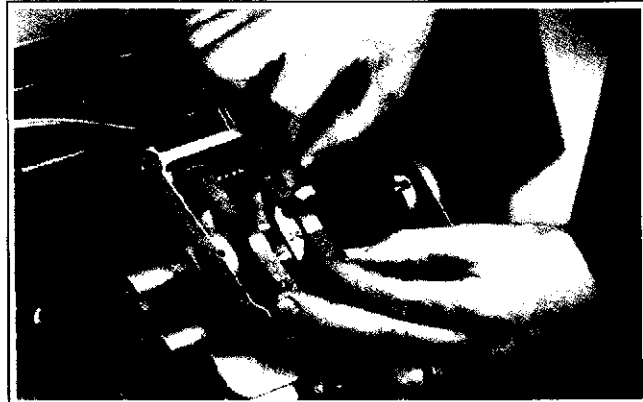


Figure 9-27. Removing Rocker Arm Assemblies (#2 Side Shown).

### Remove #2 Side Camshaft and Rocker Arms

1. Turn the camshaft until tension is off the rocker arms and the coiled spring pin is visible in the governor body. See Figure 9-28.

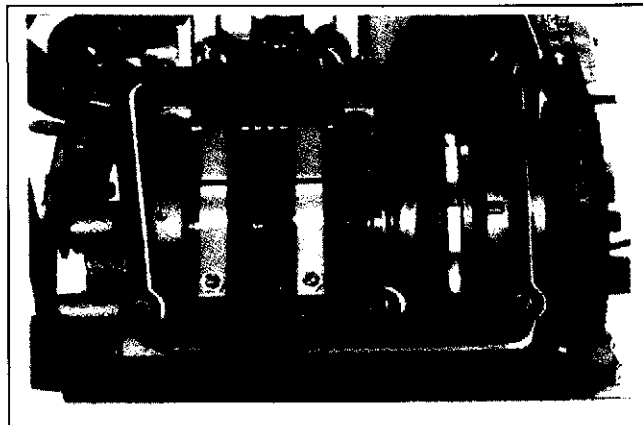


Figure 9-28. #2 Side Camshaft/Rocker Arm Detail.

2. Using a small punch, drive the coiled spring pin down about 5/8". See Figure 9-29.

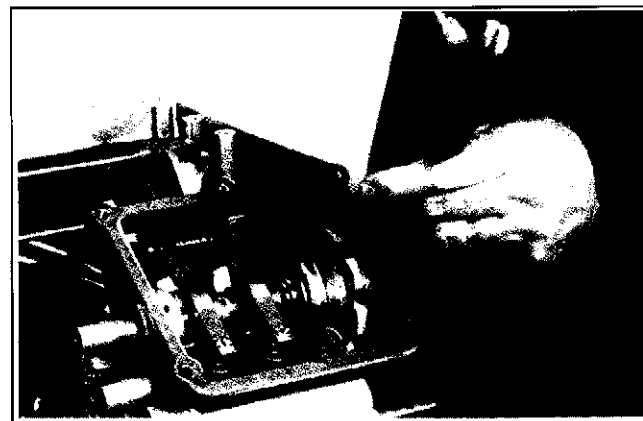


Figure 9-29. Driving Coiled Spring Pin Down.

3. Turn the camshaft 180°.
4. Grasp protruding end of the coiled spring pin with vise grip pliers. Pull the pin out of camshaft. See Figure 9-30.

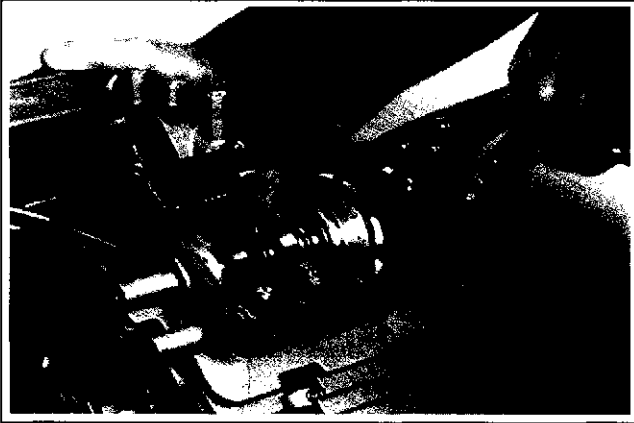


Figure 9-30. Removing Coiled Spring Pin.

5. Hold governor halves together with one hand and slide camshaft out. See Figure 9-31.



Figure 9-31. Hold Governor Together While Removing Camshaft.

6. Lift out governor assembly.
7. Remove the two hex. flange screws from the rocker arm shaft. See Figure 9-26.
8. Lift rocker arm assembly off the valve mechanism.

### Remove Governor Yoke and Cross Shaft

1. Remove the two hex. socket head screws from the governor yoke. See Figure 9-32.
2. Remove the governor cross shaft. See Figure 9-32.

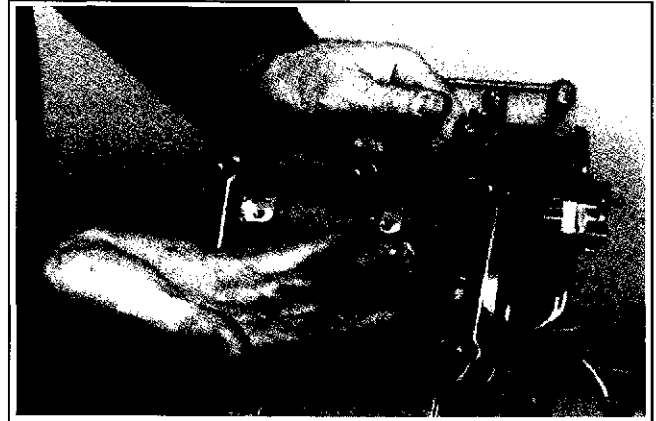


Figure 9-32. Removing Governor Yoke and Cross Shaft.

### Remove Rectifier-Regulator

1. On engines with top-mounted fuel tank, remove the wiring connector from the rectifier-regulator.
2. Remove the two mounting nuts holding the rectifier-regulator to the valley baffle. Remove the rectifier-regulator and spacer. See Figure 9-33.

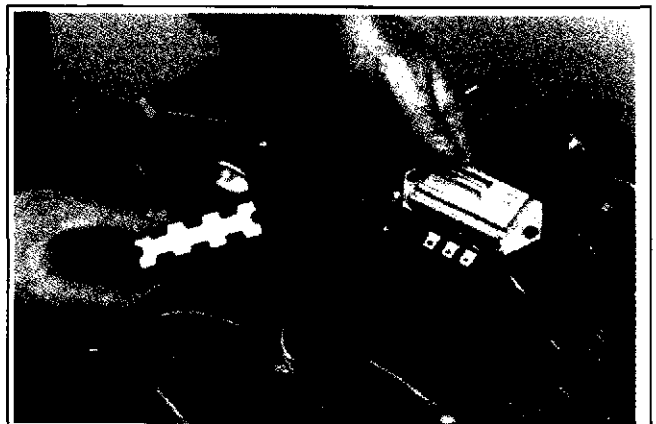


Figure 9-33. Removing Rectifier-Regulator and Spacer.

## Section 9 Disassembly

### Remove Valley Baffle

1. Remove the hex. flange screw from the wire retainer on the backside of the valley baffle.
2. Remove the hex. flange screw from the front side of the baffle and remove the baffle. See Figure 9-34.

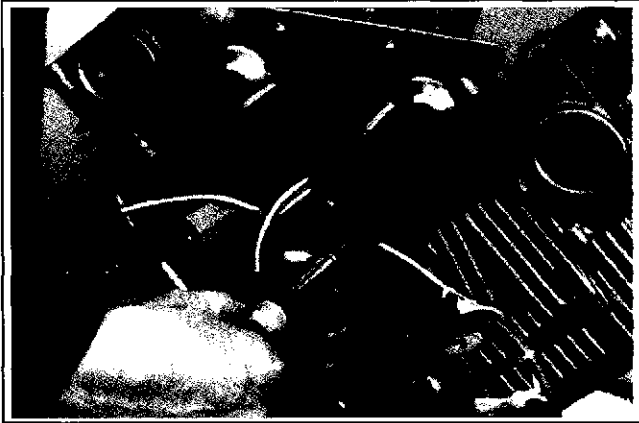


Figure 9-34. Removing Valley Baffle.

### Remove Crankcase Breather

1. Remove the two hex. flange screws securing the breather cover. See Figure 9-35.

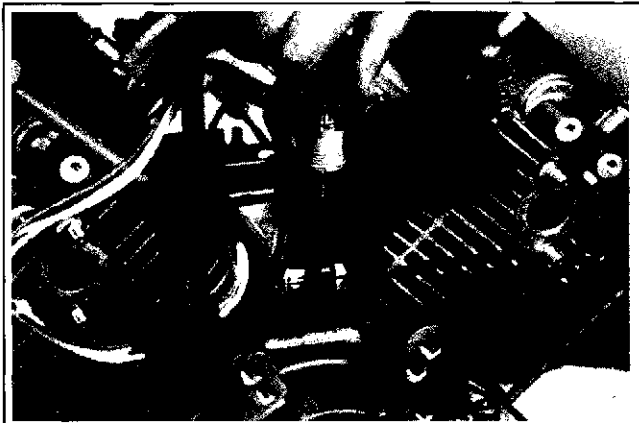


Figure 9-35. Removing Crankcase Breather Cover Screws.

2. Lift off the breather cover.
3. Remove and discard the gasket. See Figure 9-36.



Figure 9-36. Breather Cover Removal.

4. Remove the two hex. flange screws securing the breather housing to the crankcase. Remove the housing (there will be some resistance from the grommet underneath).
5. Remove the screw securing the breather stop and reed. See Figure 9-37.



Figure 9-37. Breather Stop and Reed Removal.

6. Remove rubber grommet from bottom side of the breather.

### Remove Oil Sentry™ Switch (If So Equipped)

1. Disconnect the wire lead from the Oil Sentry™ switch.
2. Remove the Oil Sentry™ switch from the oil filter adapter. See Figure 9-38.

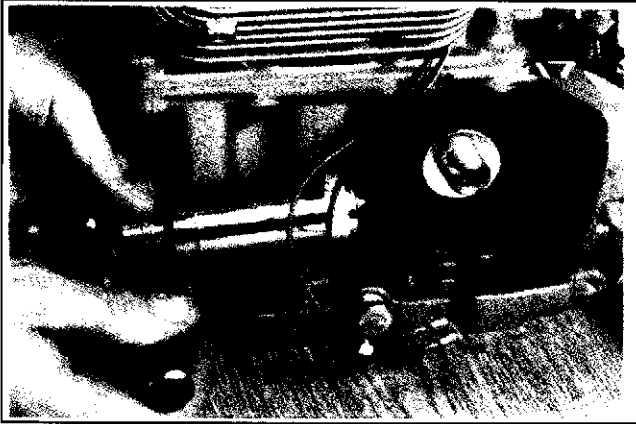


Figure 9-38. Removing Oil Sentry™ Switch.

### Remove Oil Filter Adapter

1. Remove oil filter nipple with an 8 mm (or 5/16") allen head. Turn nipple in counterclockwise direction. See Figure 9-39.

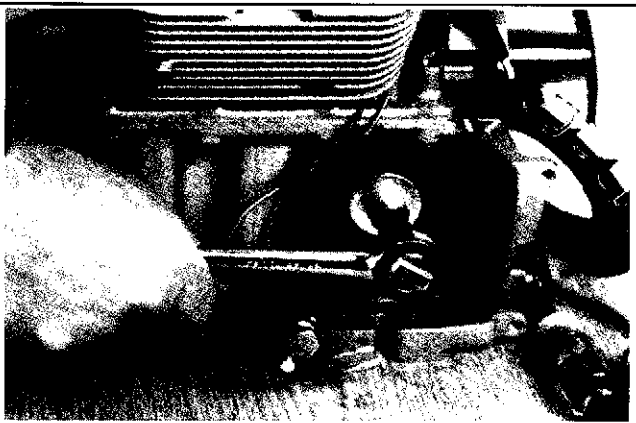


Figure 9-39. Removing Oil Filter Nipple.

2. Remove the oil filter adapter as shown in Figure 9-40.

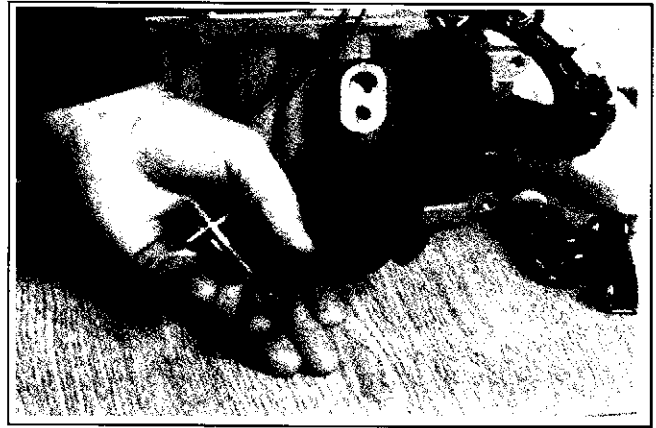


Figure 9-40. Oil Filter Adapter and Nipple.

### Separate Crankcase Halves

1. Remove the two 70 mm long screws securing crankcase halves on flywheel side. See Figure 9-41.

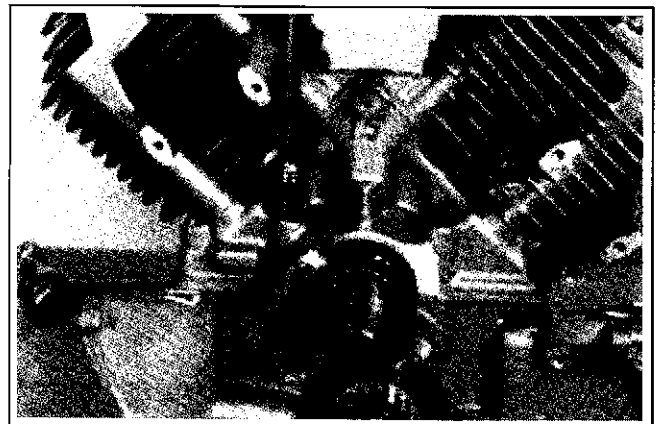


Figure 9-41. Removing the M8x70 mm Hex. Flange Screws.

## Section 9 Disassembly

- Using the engine stand (the largest piece in set 28 761 02, see Section 2, "Special Tools"), turn crankcase assembly upside down so that the lower half is on top. Remove the remaining 10 crankcase screws holding the crankcase halves together. PTO side has two 115 mm long screws; all others are 40 mm long. See Figure 9-42.

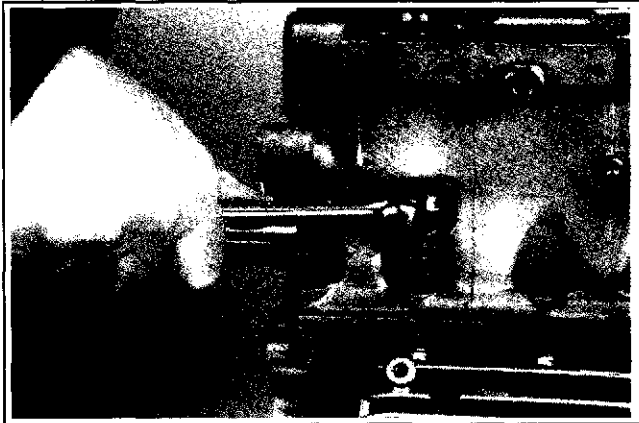


Figure 9-42. Removing the M8x40 mm Hex. Flange Screws.

- Pry between lifting tabs to separate the crankcase halves. See Figures 9-43 and 9-44.

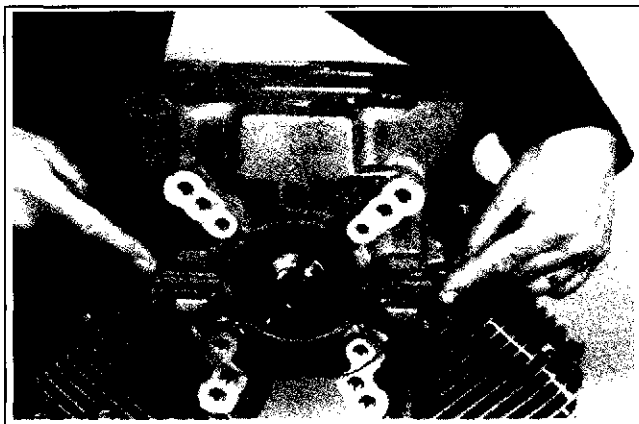


Figure 9-43. Location of the Splitting Tabs.

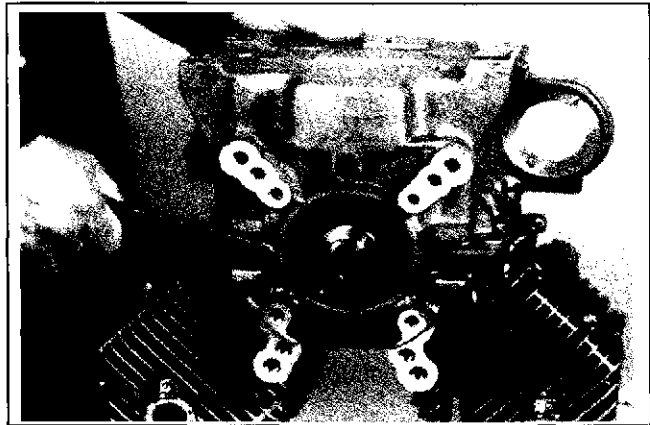


Figure 9-44. Splitting Crankcase Halves.

- Lift the lower crankcase half off the upper half. See Figure 9-45.

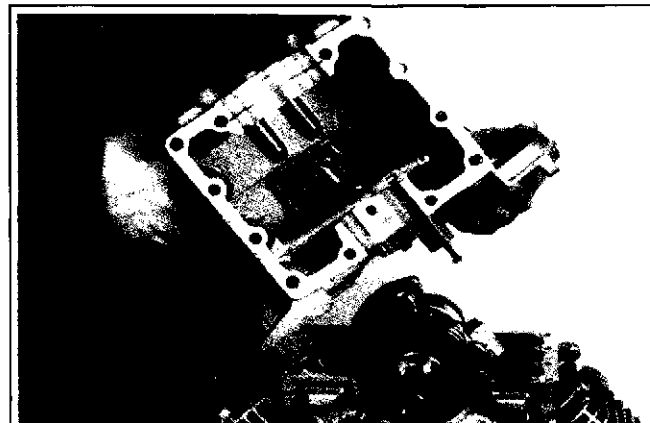


Figure 9-45. Removing Lower Crankcase Half.

- Place lower half on workbench with oil drain holes down.

### Remove Oil Pump

1. Block oil pump from turning (flywheel holding tool works well), then remove the gear retaining screw and washers. See Figure 9-46.



Figure 9-46. Removing Oil Pump Drive Gear.

2. Remove the drive gear from the pump shaft (a small gear puller may be necessary to pop it loose from the shaft). See Figure 9-47.

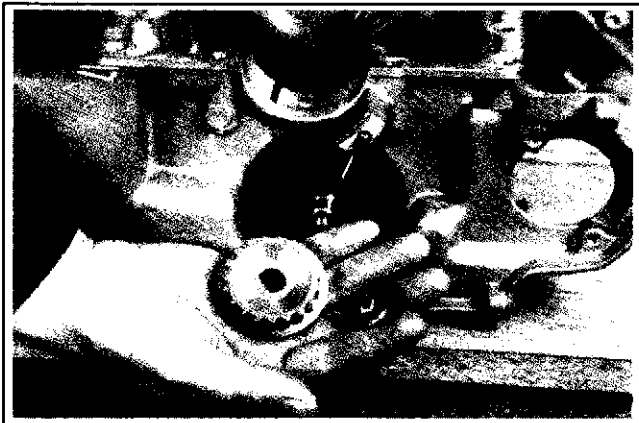


Figure 9-47. Oil Pump Gear Components.

3. Remove the three screws from the pump cover and remove the cover. See Figure 9-48.

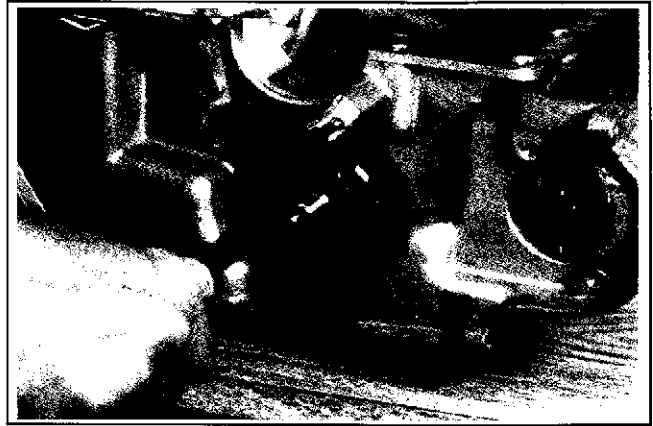


Figure 9-48. Removing Oil Pump Cover.

4. Note position of the O-Ring, ball bearing, and oil seal inside cover.
5. Remove ball bearing, wear plate, oil pump shaft with rotor, outer rotor, and O-Ring in recess of crankcase. See Figure 9-49.

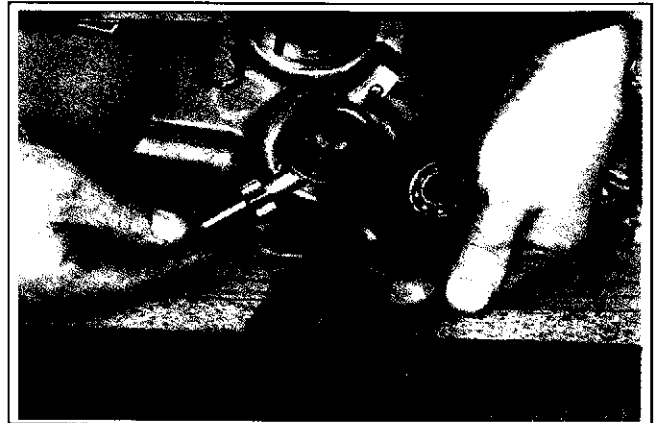


Figure 9-49. Oil Pump Ball Bearing, Wear Plate, Rotor, Shaft, and O-Ring.

## Section 9 Disassembly

### Remove Oil Pressure Relief Parts

This should only be done if a problem is suspected or there is a specific reason for removal.

1. Remove the allen head pipe plug from crankcase half. See Figure 9-50.



Figure 9-50. Removing Oil Pressure Relief Plug.

2. Use a small punch to drive out the relief valve retaining pin. See Figure 9-51.
3. Remove the relief valve spring and piston.

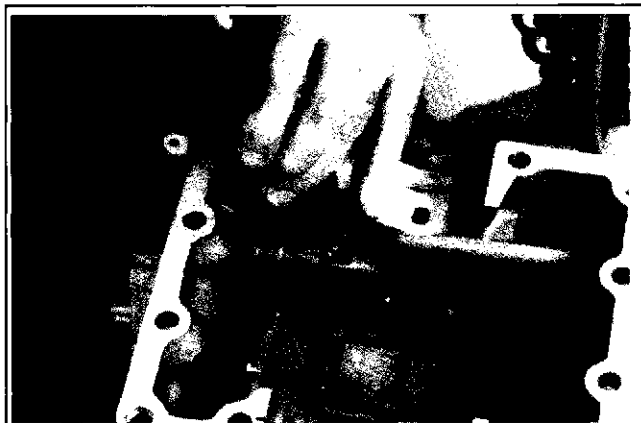


Figure 9-51. Removing Relief Valve Retaining Pin.

4. Remove the two torx head screws securing the oil screen to the bottom of the crankcase. Remove the oil filter pick-up screen. See Figure 9-52.

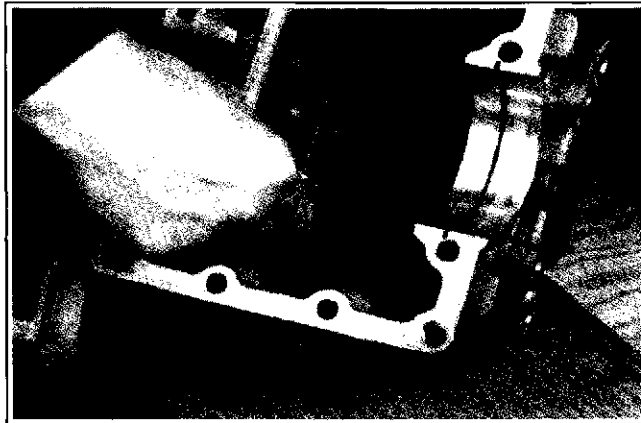


Figure 9-52. Removing Oil Filter Pick-up Screen.

### Remove Connecting Rods

1. Using the engine stand block, place upper crankcase half upside down on workbench.
2. Remove the connecting rod cap screws. See Figure 9-53.

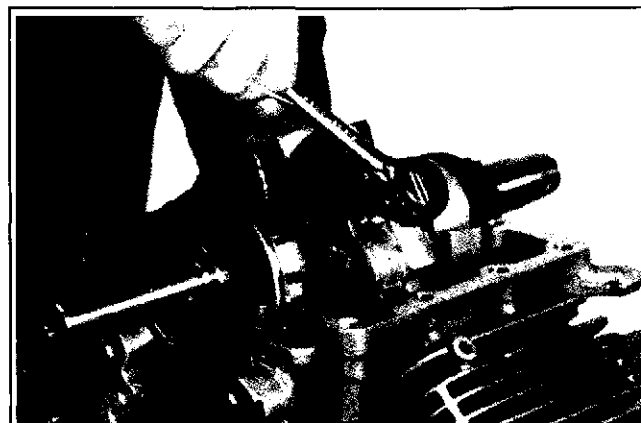


Figure 9-53. Removing Connecting Rod Caps.

3. Before removing connecting rod caps, note that the match marks on the rods face toward the outside of the crankcase. Number the rod caps (#1 is nearest the flywheel end). **Do not** mix end caps and connecting rods.
4. Lift connecting rod caps off crankshaft journals.



### Remove Crankshaft

1. Lift the crankshaft assembly straight up out of the crankcase half. See Figure 9-54.

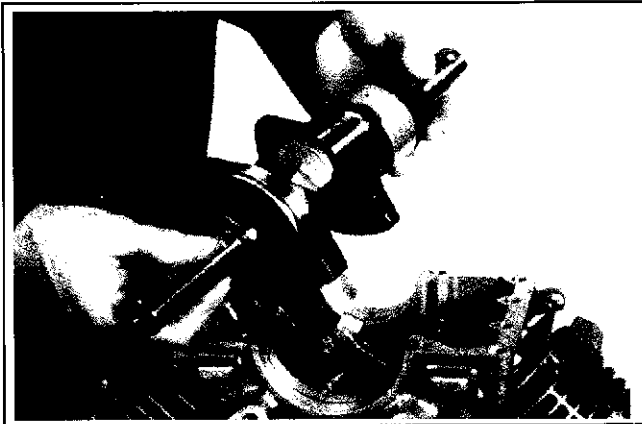


Figure 9-54. Removing Crankshaft Assembly.

2. Place crankshaft on workbench for further disassembly.
3. Loosely reassemble rod caps to the correct connecting rod to keep them as sets.

### Crankshaft Disassembly

1. The belt drive sprocket has a low interference fit onto the crankshaft. If it will not slide off, heat the gear slightly with a propane torch until it expands and loosens, then remove it with a shop towel or glove. See Figure 9-55.



Figure 9-55. Belt Drive Sprocket Removed.

2. Use a pliers or side cutter to remove the sprocket key from the crankshaft.

3. Remove the oil seal and sleeve bearing from the front end of the crankshaft. Discard the oil seal. See Figure 9-56.

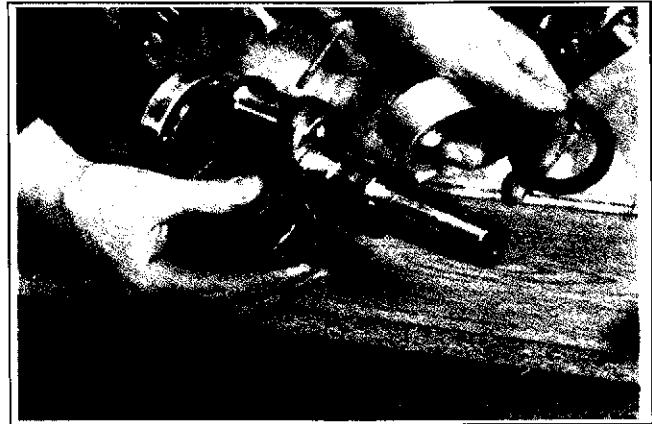


Figure 9-56. Sprocket, Oil Seal, and Sleeve Bearing Removed.

4. Remove the oil seal and ball bearing from PTO end of crankshaft. Use puller or press to remove bearing. TH18 engines have an additional snap ring on crankshaft to lock ball bearing in position. It must be removed to remove bearing. Discard the oil seal. See Figure 9-57.

NOTE: Snap ring must stay on bearing.



Figure 9-57. Oil Seal Removed From PTO End.

## Section 9 Disassembly

### Remove Connecting Rods With Pistons and Rings

1. Pull the piston assemblies out of both cylinders. See Figure 9-58. If reusable, mark the connecting rods and pistons to match the caps. Remove and discard the piston rings.

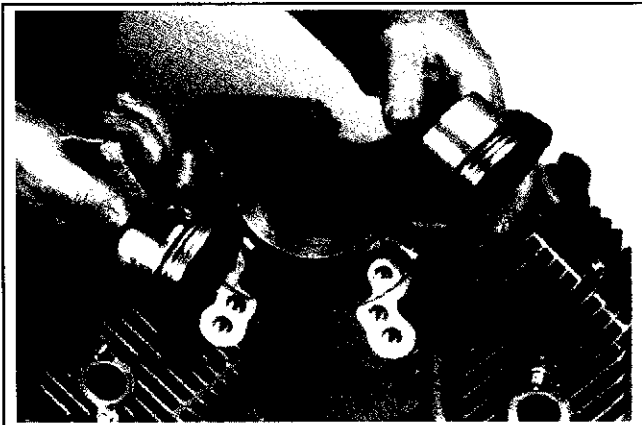


Figure 9-58. Piston Assemblies Removed.

2. To completely disassemble, remove the piston pin retainers and separate pistons from connecting rods. Refer to "Reconditioning" Section 10.

### Remove Valve Train

1. Install valve blocking tools into the cylinders. Install the cover plate and secure with two of the M8x40 mm crankcase bolts. Refer to Section 2 "Special Tools." The valves would fall free without the tool on this engine design. See Figure 9-59.

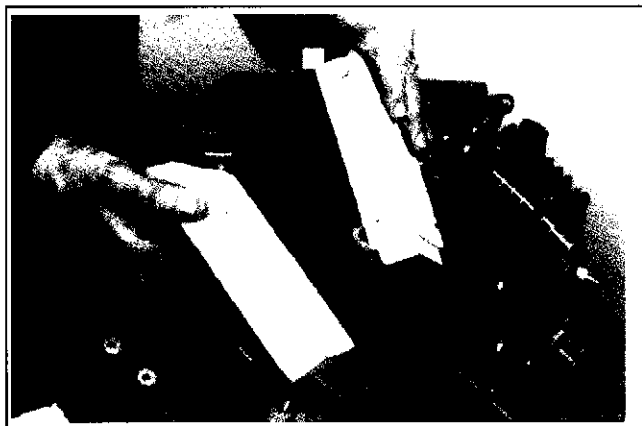


Figure 9-59. Special Valve Blocking Tools.

2. Turn the crankcase upright, compress the valve springs, and remove the valve keepers. See Figure 9-60.

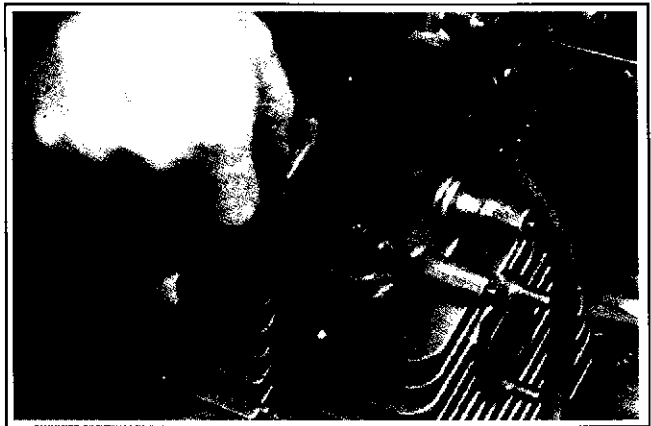


Figure 9-60. Compress Springs to Remove Keepers.

3. Turn crankcase over again for access to valves.
4. Use the suction cup end of a valve lapping tool to pull the valves out. Refer to "Reconditioning" Section 10. See Figure 9-61.

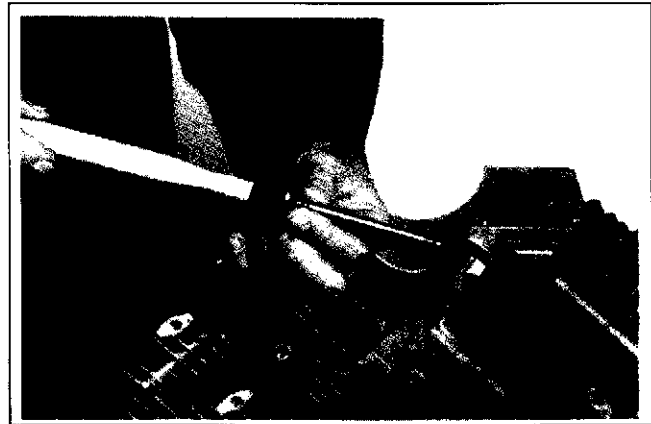


Figure 9-61. Removing Valves.

## Section 10

# Inspection and Reconditioning

This section covers the operation, inspection, and repair/reconditioning of major internal engine components. The following components are not covered in this section. They are covered in sections of their own:

Air Cleaner, Section 4  
Fuel System & Governor, Section 5  
Retractable Starter, Section 7  
Ignition, Charging & Electric Starter, Section 8

Clean all parts thoroughly. Only clean parts can be accurately inspected and gauged for wear or damage. There are many commercially available cleaners that will quickly remove grease, oil, and grime from engine parts. When such a cleaner is used, follow the manufacturer's instructions and safety precautions carefully. Make sure all traces of the cleaner are removed before the engine is reassembled and placed into operation. Even small amounts of these cleaners can quickly break down the lubricating properties of engine oil.

Use gasket remover or paint remover to remove the old RTV from the crankcase halves. Do not scrape the surfaces when cleaning as this will damage the surfaces. This could result in leaks.

Refer to "A Guide to Engine Rebuilding" (TP-2150) for additional information. "Measurement Guide" (TP-2159-A) and "Engine Inspection Data Record" (TP-2435) are also available; use these to record inspection results.

## Section 10 Inspection and Reconditioning

### Camshafts

This engine features two overhead camshafts which are belt driven off the crankshaft. The camshaft on the #1 side drives the mechanical fuel pump which is part of the #1 side valve cover. The #2 side camshaft includes governor components to limit top governed speed. Refer to Section 5 for information on governor function.

### Inspection and Service

Inspect cam lobes for signs of wear. Replace camshaft if it is badly worn. If the sprocket is damaged or worn, replace it.

NOTE: The same sprocket is used on both camshafts. On the #1 camshaft, it is mounted with the #1 visible to the front. On the #2 camshaft, it is reversed so the #2 is visible.

### Crankshaft

The crankshaft assembly on this engine includes a sprocket for driving the timing belt, a sleeve bearing on the flywheel end, and a ball bearing on the PTO end. The ball bearing includes a locating snap ring which controls end play of the crankshaft. Inspect and/or service components as follows:

### Inspection and Service

Inspect the teeth of the sprocket. Replace the sprocket if the teeth are badly worn, chipped, or missing. Depending on tolerances, the sprocket is usually a light press fit on the crankshaft and is keyed to the shaft. Install as follows.

1. Install key in keyway for sprocket. See Figure 10-1.

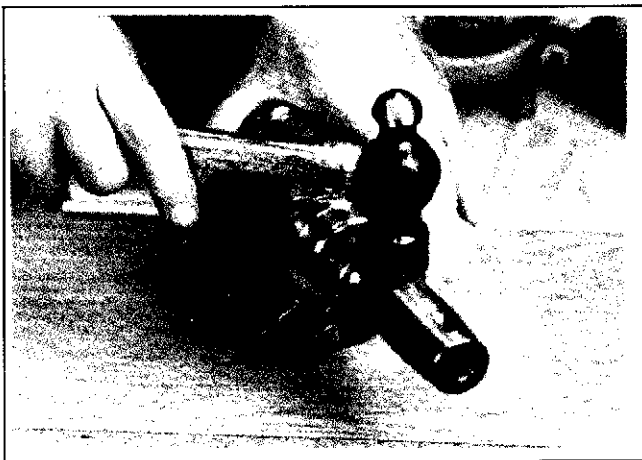


Figure 10-1. Installing Key For Sprocket.

2. If needed, heat sprocket with a 60 watt light bulb or on a hot plate. Then slip it into position on crankshaft. See Figure 10-2.



Figure 10-2. Heat Sprocket Before Installing.

Inspect the crankshaft keyways. If worn or chipped, replacement of the crankshaft will be necessary.

Inspect the crankpin for score marks or metallic pickup. Slight score marks can be cleaned with crocus cloth soaked in oil. If wear limits, as stated in "Specifications and Tolerances" are exceeded, it will be necessary to either replace the crankshaft or regrind the crankpin to **0.25 mm (0.010 in.)** undersize. If reground, **0.25 mm (0.010 in.)** undersize connecting rods (big end) must then be used to achieve proper running clearance. Measure the crankpin for size, taper, and out-of-round.

NOTE: If the crankpin is reground, visually check to insure that the fillet blends smoothly with the crankpin surface. See Figure 10-3.

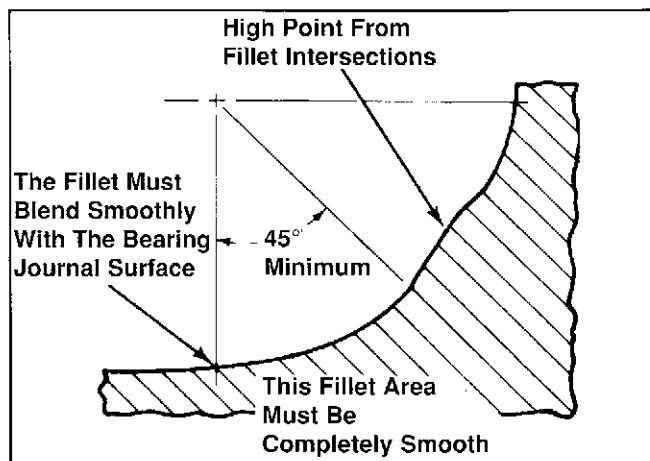


Figure 10-3. Crankpin Fillets.

## Section 10 Inspection and Reconditioning

Inspect the main bearings and journals. Check sleeve bearing surface for scoring, grooving, or excessive wear. To replace, slide old bearing off and new in its place. Note locating pin in crankcase to align bearing. Replacement sleeve bearings are available in standard and **0.25 mm (0.010 in.)** undersize.

If PTO end ball bearing turns easily and noiselessly, reuse. Press replacement bearing on if needed. Install snap ring on TH18. See Figure 10-4.

If the sleeve bearing journal is worn or damaged, it can be ground **0.25 mm (0.010 in.)** undersize and fitted with an undersize bearing.

When grinding a crankshaft, grinding stone deposits can get caught in oil passages which could cause severe engine damage. Removing the plug each time the crankshaft is ground provides easy access for cleaning any grinding deposits that may collect in the oil passages. See Figure 10-4.

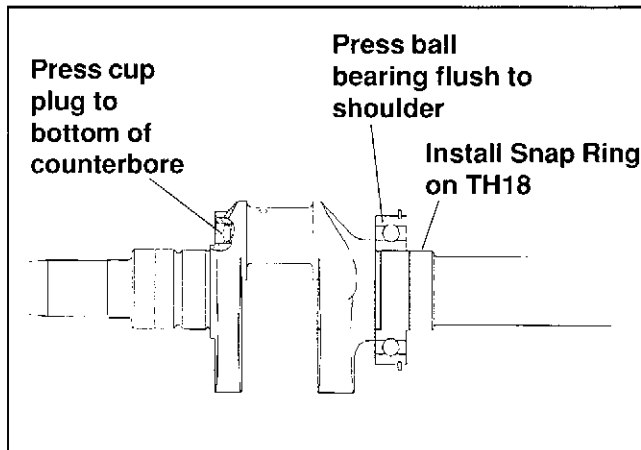


Figure 10-4. Cup plug, Ball Bearing Installation Detail.

Use the following procedures to remove and replace the plug:

### Procedure to Remove Crankshaft Plug:

1. Drill a 3/16" hole through the plug in the crankshaft.
2. Thread a 3/4" or 1" long self-tapping screw with a flat washer into the drilled hole. The flat washer must be large enough to seat against the shoulder of the plug bore. See Figure 10-5.

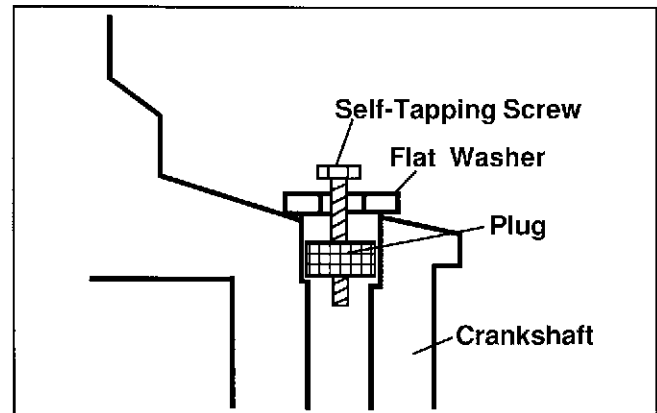


Figure 10-5. Removing Crankpin Plug.

3. Tighten the self-tapping screw until it draws the plug out of the crankshaft.

### Procedure to Install New Plug:

1. Use a single cylinder camshaft pin Part No. 47 380 09 as a driver and tap the plug into the plug bore until it seats at the bottom of the bore. Make sure the plug is tapped in evenly to prevent leakage.

## Section 10

### Inspection and Reconditioning

#### Cylinder Bore

##### Inspection and Service

Check the cylinder bores for scoring. Unburned fuel can result in scuffing and scoring of the cylinder wall. It washes the necessary lubricating oils off the piston and cylinder wall. As raw fuel seeps down the cylinder wall, the piston rings make metal-to-metal contact with the wall. Scoring of the cylinder wall can also be caused by localized hot spots resulting from blocked cooling fins or from inadequate or contaminated lubrication.

If either of the cylinder bores is badly scored, excessively worn, tapered, or out of round, replacement of the upper crankcase half will be necessary. Non-replaceable liners are included in the upper crankcase. These are not to be rebored. Oversize pistons and rings are not available for these engines.

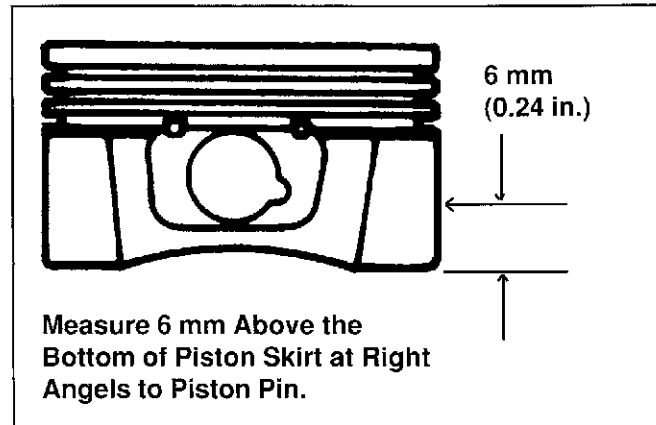
##### Measuring Piston-to-Bore Clearance

Before installing the piston into the cylinder bore, it is necessary that the clearance be accurately checked. This step is often overlooked, and if the clearances are not within specifications, engine failure will usually result.

**NOTE:** Do not use a feeler gauge to measure piston-to-bore clearance -- it will yield inaccurate measurements. Always use a micrometer.

Use the following procedure to accurately measure the piston-to-bore clearance:

1. Use a micrometer and measure the diameter of the piston **6 mm (0.24 in.)** above the bottom of the piston skirt and perpendicular to the piston pin. See Figure 10-6.



**Figure 10-6. Measuring Piston Diameter.**

2. Use an inside micrometer, telescoping gauge, or bore gauge and measure the cylinder bore. Take the measurement approximately **63.5 mm (2.5 in.)** below the top of the bore and perpendicular to the piston pin.
3. Piston-to-bore clearance is the difference between the bore diameter and the piston diameter (step 2 minus step 1).

#### Flywheel

##### Inspection

Inspect the flywheel for cracks, and the flywheel keyway for damage. Replace flywheel if cracked. Replace the flywheel, the crankshaft, and the key if flywheel key is sheared or the keyway is damaged.

#### Fuel Pump

A mechanical type fuel pump is used on this engine. The pump is an integral part of the valve cover on the #1 side.

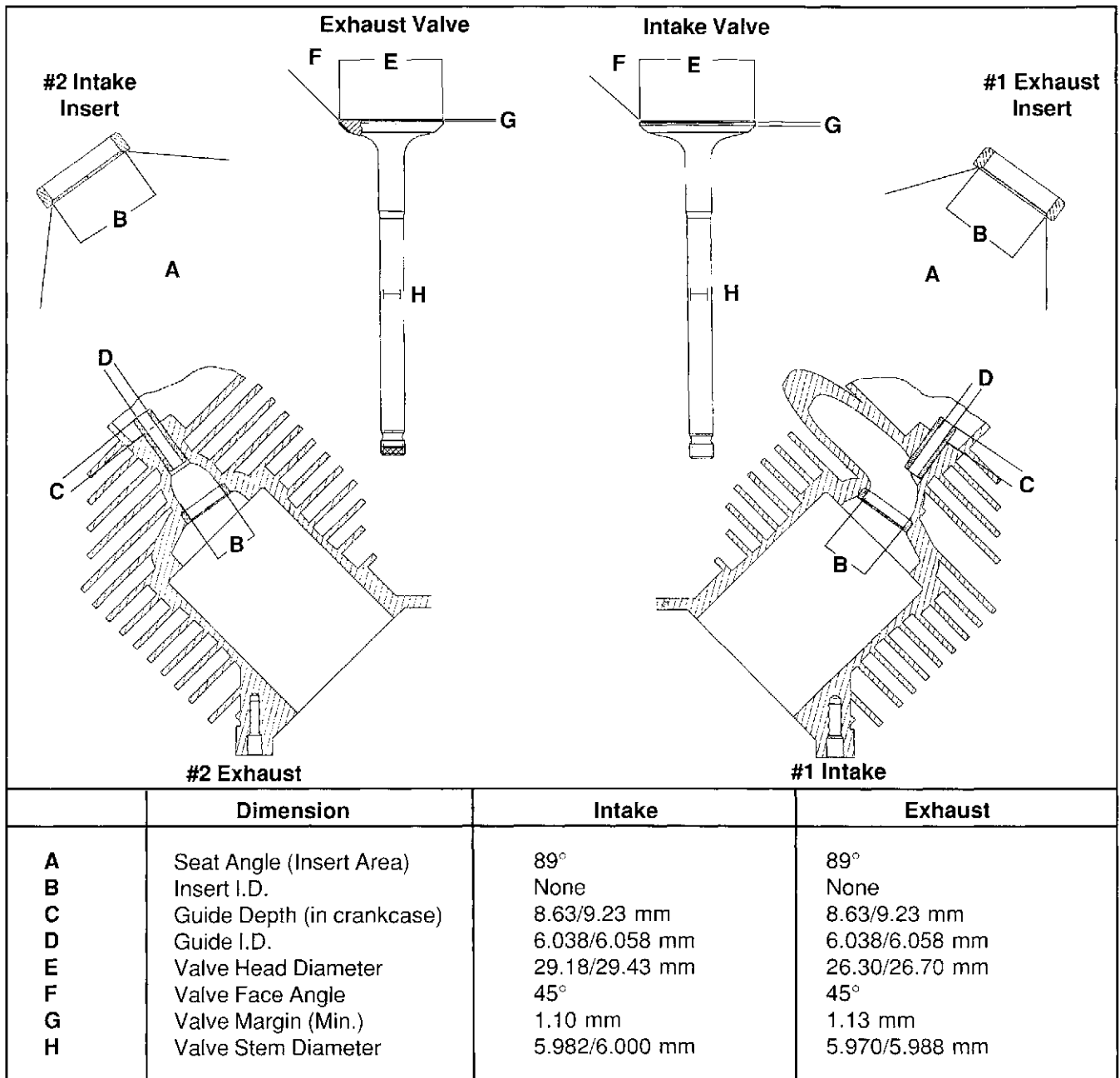
The pump is driven off a lobe on the #1 side camshaft. If faulty, replace the #1 valve cover/fuel pump assembly. The pump itself is not serviceable.

**Valves**

Hard starting, or loss of power accompanied by high fuel consumption may be symptoms of faulty valves. After removal, clean the valve heads, faces, and stems with a power wire brush. Then, carefully inspect each valve for defects such as warped heads, excessive corrosion, or worn stem ends. Replace valves found to be in bad condition. A normal valve and valves in bad condition are shown in the valve illustrations on the following pages.

**Inspection and Service**

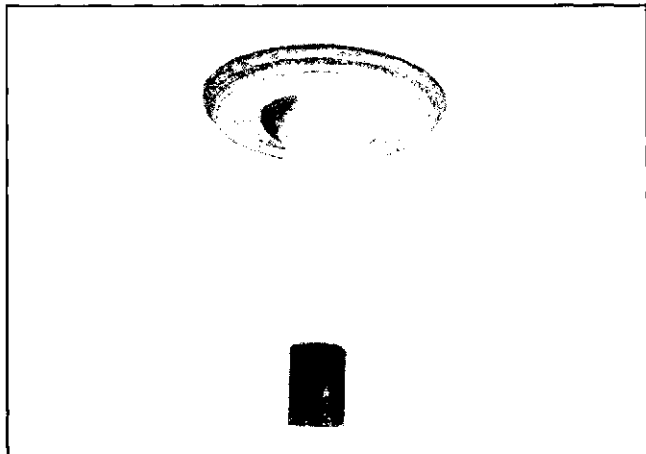
Carefully inspect the valve mechanism parts. Inspect the valve springs and related hardware for excessive wear or distortion. Check the valves and valve seat area inserts in the upper crankcase area for evidence of deep pitting, cracks, or distortion. Check the clearance of the valve stems in guides. See Figure 10-7 for valve details and specifications.



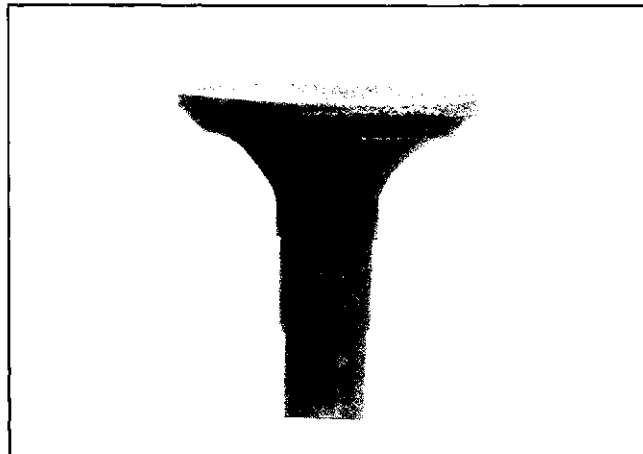
**Figure 10-7. Valve Details.**

## Section 10 Inspection and Reconditioning

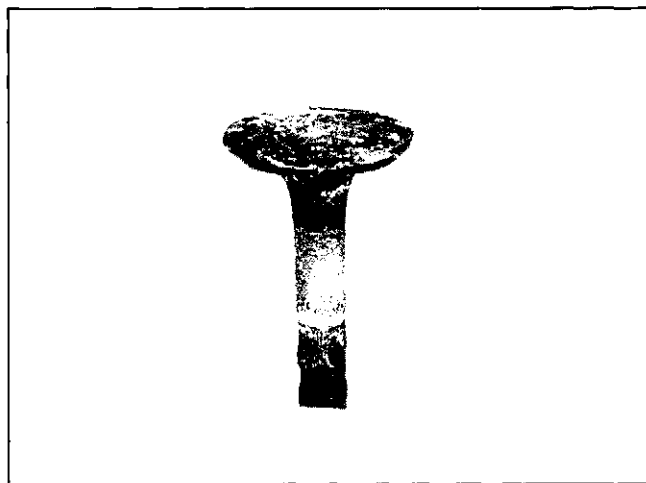
---



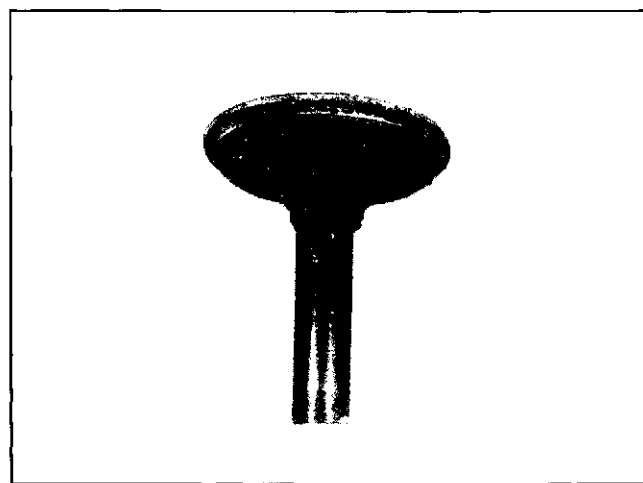
**Normal:** Even after long hours of operation a valve can be reconditioned and reused if the face and margin are in good shape. If a valve is worn to where the margin is less than 1/32" do not reuse it. The valve shown was in operation for almost 1000 hours under controlled test conditions.



**Leakage:** A poor grind on face or seat of valve will allow leakage resulting in a burned valve on one side only.

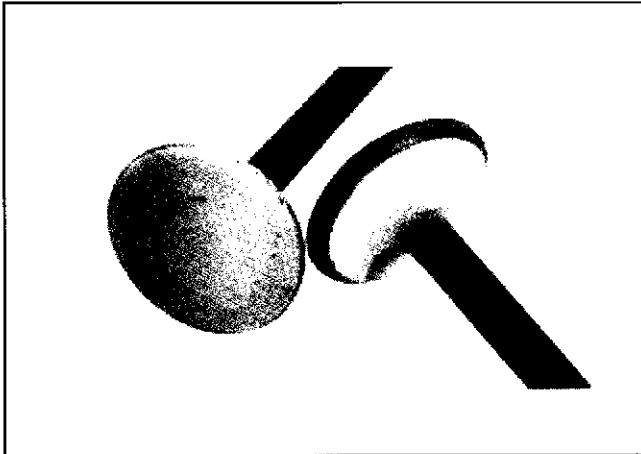


**Bad Condition:** The valve depicted here should be replaced. Note the warped head; margin damaged and too narrow. These conditions could be attributed to excessive hours or a combination of poor operating conditions.

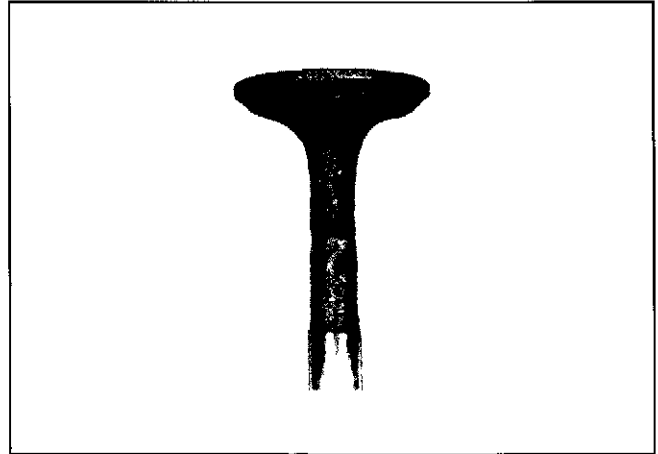


**Coking:** Coking is normal on intake valves and is not harmful. If the seat is good, the valve could be reused after cleaning.

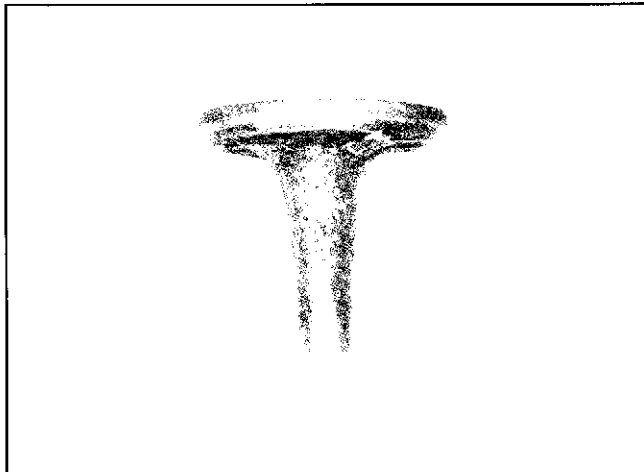




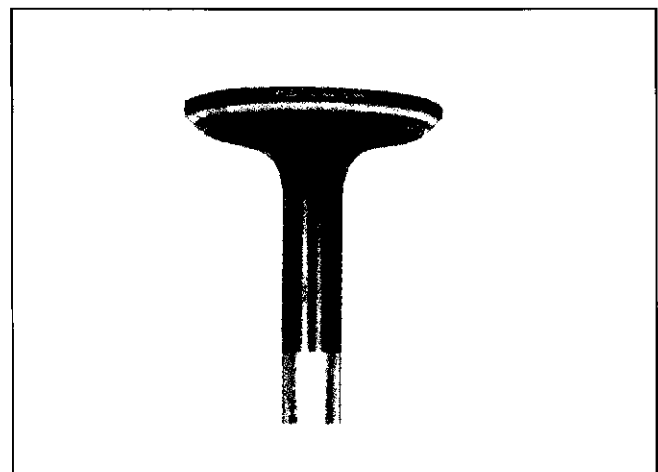
**Excessive Combustion Temperatures:** The white deposits seen here indicate very high combustion temperatures, usually due to a lean fuel mixture.



**Stem Corrosion:** Moisture in the fuel, or condensation are the most common causes of valve stem corrosion. Condensation occurs from improper preservation during storage and when engine is repeatedly stopped before it has a chance to reach normal operating temperatures. Replace corroded valves.



**Gum:** Gum deposits usually result from using stale gasoline. Gum is a prevalent cause of valve sticking. The cure is to ream the valve guides and clean or replace the valves, depending on their condition.



**Overheating:** An exhaust valve subject to overheating will have a dark discoloration in the area above the valve guide. Worn guides and faulty valve springs may cause this condition. Also check for clogged air intake, and blocked fins when this condition is noted.

## Section 10

### Inspection and Reconditioning

#### Valve Guides

If a valve guide is worn beyond specifications, it will not guide the valve in a straight line. This may result in burnt valve faces or seats, loss of compression, and excessive oil consumption.

To check valve guide-to-valve stem clearance, thoroughly clean the valve guide and, using a split-ball gauge, measure the inside diameter. Then, using an outside micrometer, measure the diameter of the valve stem at several points on the stem where it moves in the valve guide. Use the largest stem diameter to calculate the clearance. If the **intake** clearance exceeds **0.038/0.076 mm (0.0015/0.0030 in.)** or the **exhaust** clearance exceeds **0.050/0.088 mm (0.0020/0.0035 in.)**, determine whether the valve stem or guide is responsible for the excessive clearance.

Maximum (I.D.) wear on the **intake** valve guide is **6.13 mm (0.2413 in.)** while **6.19 mm (0.2437 in.)** is the maximum allowed on the exhaust guide. The guides are not removable but can be reamed **0.25 mm (0.010 in.)** oversize. Valves with **0.25 mm** oversize stems must then be used.

If the guides are within limits but the valve stems are worn beyond limits, replace with new valves.

#### Valve Seat Inserts

Hardened steel alloy intake and exhaust valve seat inserts are press-fitted into the upper crankcase half. The inserts are not replaceable on the engines but can be reconditioned if not too badly pitted or distorted. If cracked or badly warped, upper crankcase should be replaced.

Recondition the valve seat inserts following the instructions provided with the valve seat cutter being used. A typical cutter is shown in Figure 10-8. The final cut should be made with an 89° cutter as specified for the valve seat angle in Figure 10-7. With the proper 45° valve face angle as specified in Figure 10-7 and the valve seat cut properly (44.5° as measured from centerline when cut 89°) this would result in the desired 0.5° (1.0° full cut) interference angle where the maximum pressure occurs on the outside diameters of valve face and seat.

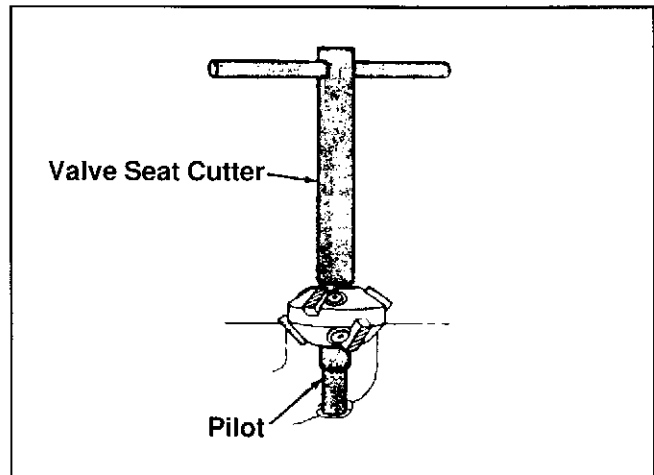


Figure 10-8. Typical Valve Seat Cutter.

#### Lapping Valves

Reground or new valves must be lapped in, to provide fit. Use a hand valve grinder with suction cup for final lapping. Lightly coat valve face with "fine" grade of grinding compound, then rotate valve on seat with grinder. Continue grinding until a smooth surface is obtained on the seat and on the valve face. Thoroughly clean upper crankcase and valve in soap and hot water to remove all traces of grinding compound. After drying parts, apply light coating of **SAE 10** oil to prevent rusting.

#### Pistons and Rings

##### Inspection

Scuffing and scoring of pistons and cylinder walls occurs when internal temperatures approach the welding point of the piston. Temperatures high enough to do this are created by friction, which is usually attributed to improper lubrication, and/or overheating of the engine.

Normally, very little wear takes place in the piston boss-piston pin area. If the original piston and connecting rod can be reused after new rings are installed, the original pin can also be reused but new piston pin retainers are required. The piston pin is included as part of the piston assembly - if the pin boss in piston or the pin, are worn or damaged, a new piston assembly is required.

## Section 10

# Inspection and Reconditioning

Ring failure is usually indicated by excessive oil consumption and blue exhaust smoke. When rings fail, oil is allowed to enter the combustion chamber where it is burned along with the fuel. High oil consumption can also occur when the piston ring end gap is incorrect because the ring cannot properly conform to the cylinder wall under this condition. Oil control is also lost when ring gaps are not staggered during installation.

When cylinder temperatures get too high, lacquer and varnish collect on the pistons causing the rings to stick, which results in rapid wear.

Scratches on the rings and pistons are caused by abrasive material such as carbon, dirt, or pieces of hard metal.

Detonation damage occurs when a portion of the fuel charge ignites spontaneously from heat and pressure shortly after ignition. This creates two flame fronts which meet and explode to create extreme hammering pressures on a specific area of the piston. Detonation generally occurs from using low octane fuels.

Preignition or ignition of the fuel charge before the timed spark can cause damage similar to detonation. Preignition damage is often more severe than detonation damage. Preignition is caused by a hot spot in the combustion chamber from sources such as: glowing carbon deposits, blocked fins, improperly seated valve, or wrong spark plug.

Replacement pistons are available in STD bore size only. Replacement pistons include new piston ring sets and new piston pins.

Service replacement piston ring sets are also available separately in STD bore size only. Always use new piston rings when installing pistons. **Never reuse old rings.**

Some important points to remember when servicing piston rings:

1. The bore must be deglazed before service ring sets are used. Use **only** a ball hone for deglazing or renewing crosshatch. Do not use any other type. Do not allow the balls to contact the combustion chamber surfaces.
2. If the bore is good, and the old piston is within wear limits and free of score or scuff marks, the old piston may be reused.
3. Remove old rings and clean up grooves. **Never reuse old rings.**
4. Before installing the rings on piston, place the top two rings, each in turn, in its running area in cylinder bore and check end gap (see Figure 10-9). Top ring end gap is **0.180/0.380 mm (0.0071/0.0150 in.)**. Middle ring end gap is **0.180/0.440 mm (0.0071/0.0173 in.)** for TH16 and **0.180/0.450 mm (0.0071/0.0177 in.)** for TH18.

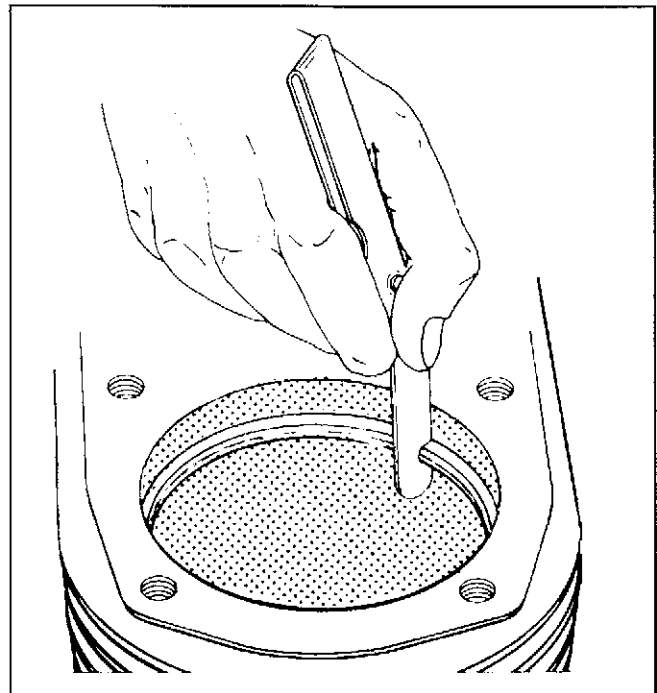


Figure 10-9. Measuring Piston Ring End Gap.

## Section 10

### Inspection and Reconditioning

5. After installing the new compression (top and middle) rings on piston, check piston-to-ring side clearance. Top ring side clearance is **0.040/0.085 mm (0.0016/0.0033 in.)** for TH16 and TH18. Middle ring side clearance is **0.030/0.080 mm (0.0012/0.0031 in.)** for TH16 and **0.030/0.076 mm (0.0012/0.0030 in.)** for TH18. If side clearance is greater than specified, a new piston **must** be used. Refer to Figure 10-10.

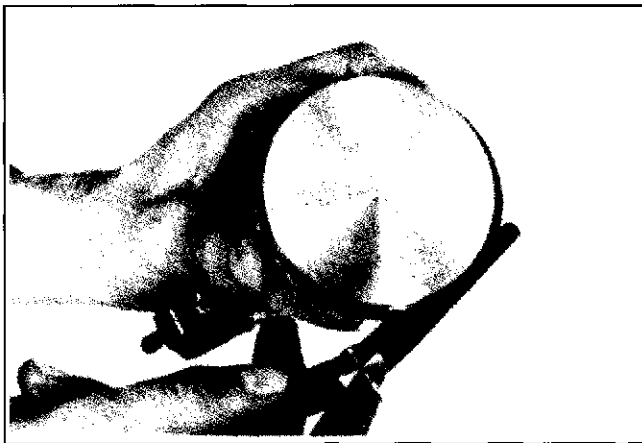


Figure 10-10. Measuring Piston Ring Side Clearance.

#### Install New Piston Rings

To install piston rings, proceed as follows:

**NOTE:** Rings must be installed correctly. Ring installation instructions are usually included with new ring sets. Follow instructions carefully. Use a piston ring expander to install rings (see Figure 10-11). Install the bottom (oil control) ring first and the top compression ring last. Refer to Figure 10-12.

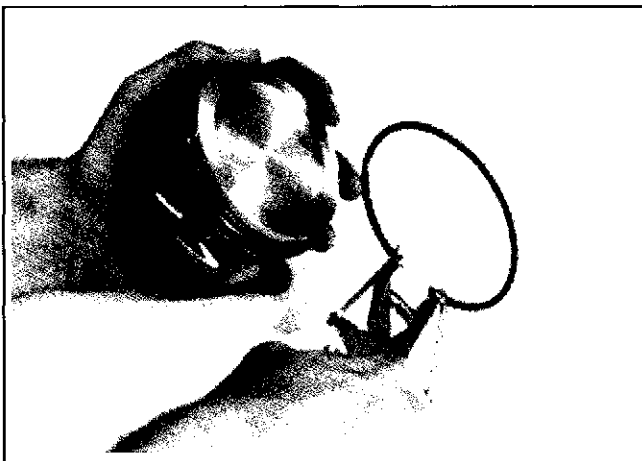


Figure 10-11. Installing Piston Rings with Expander.

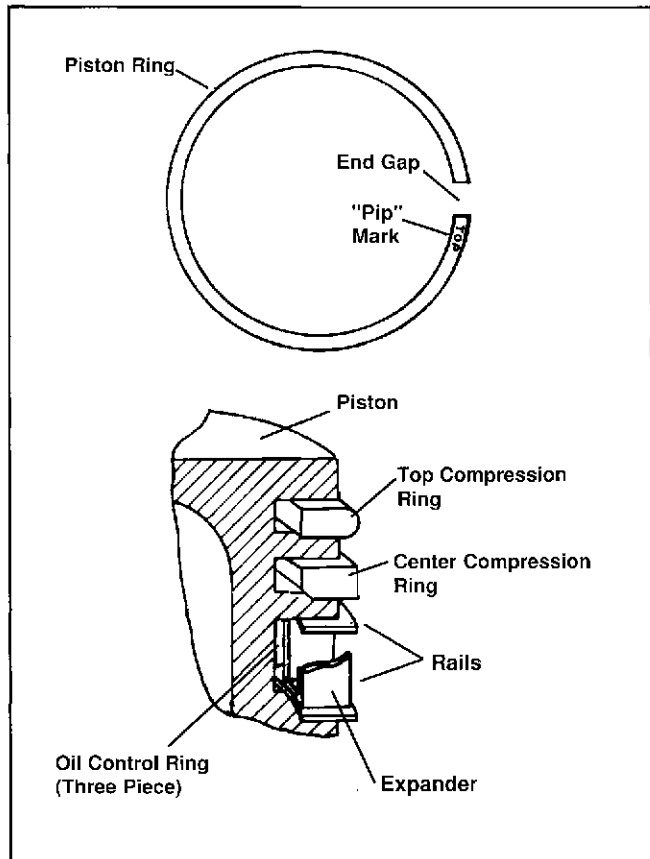


Figure 10-12. Piston Ring Installation.

1. Oil Control Ring (Bottom Groove): Install the expander and then the rails. Make sure the ends of expander are not overlapped.
2. Compression Ring (Center Groove): Install the center ring using a piston ring installation tool. Make sure the "pip" mark is up.
3. Compression Ring (Top Groove): Install the top ring using a piston ring installation tool.

### Connecting Rods

Offset Stepped-Cap Connecting Rods are used in these engines.

### Inspection and Service

Check bearing area (big end) for excessive wear, score marks, running and side clearances (refer to Section 1, "Specifications, Tolerances, and Special Torque Values"). Replace rod and cap if scored or excessively worn.

Service replacement connecting rods are available in STD crankpin size, and **0.25 mm (0.010 in.)** undersize. The **0.25 mm (0.010 in.)** undersized rod can be identified by the drilled hole located in the lower end of the rod shank. Always refer to the appropriate parts information to ensure that correct replacements are used.

### Oil Seals in Crankcase Halves

Always install new oil seals when reconditioning an engine. There are two different seals for the crankshaft. Lubricate these with engine oil before installation.

Use a seal driver and press to the depth shown in Figure 10-13. Install crankshaft oil seals after the crankshaft assembly is in position (refer to Section 11 "Reassembly").

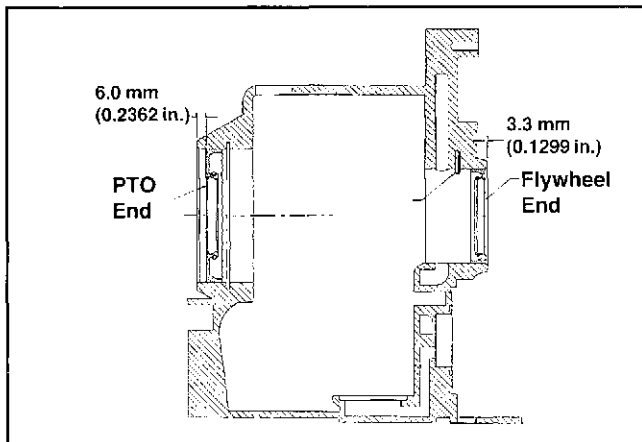


Figure 10-13. Crankshaft Oil Seals.

The oil seals for the camshafts can be installed in the upper crankcase assembly at this time. Lubricate the seals with engine oil and use a seal driver to the depth shown in Figure 10-14.

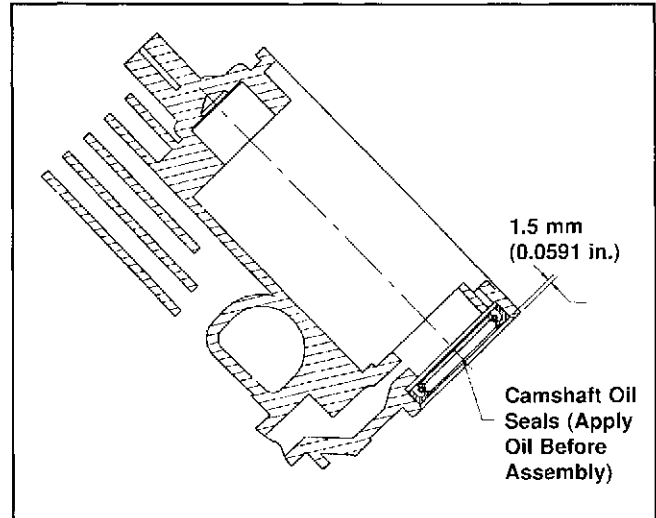


Figure 10-14. Camshaft Oil Seals.

The governor shaft oil seal can also be installed at this time. Lubricate the seal with engine oil and press into the #2 side crankcase to the depth shown in Figure 10-15.

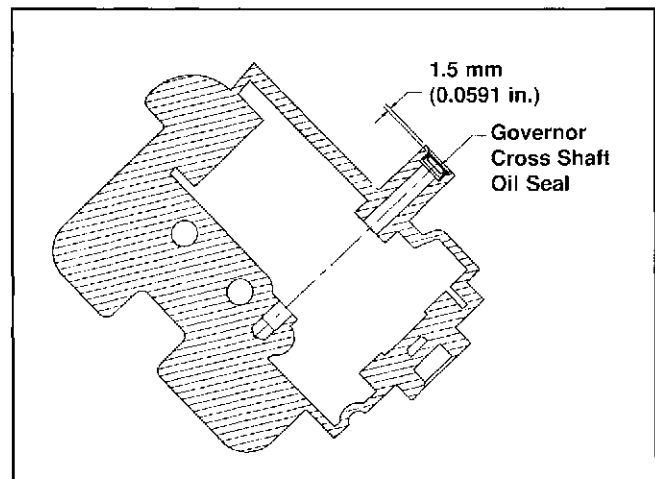
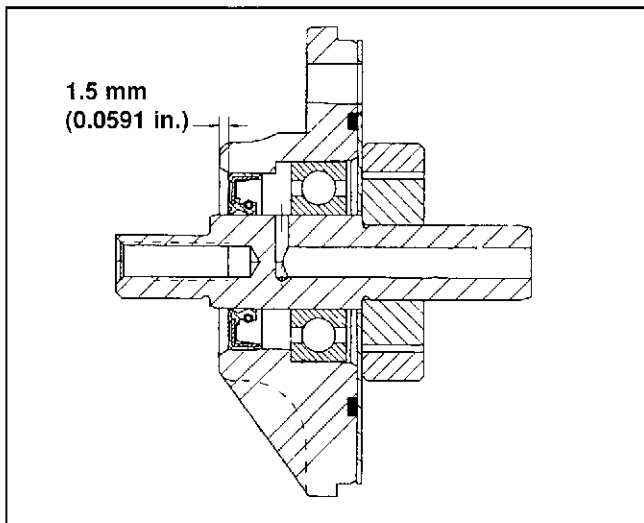


Figure 10-15. Governor Cross Shaft Oil Seal.

## Section 10 Inspection and Reconditioning

The oil seal for the oil pump is pressed into the pump cover to a depth of 1.5 mm as shown in Figure 10-16.



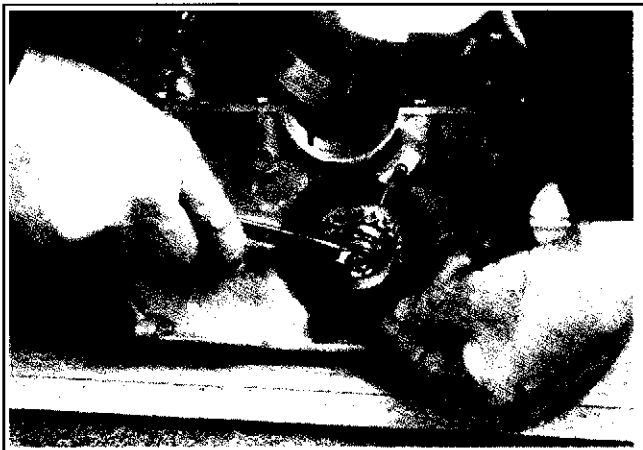
**Figure 10-16. Cross-Sectioned View of Oil Pump Showing Oil Seal Depth.**

### Oil Pump Reconditioning

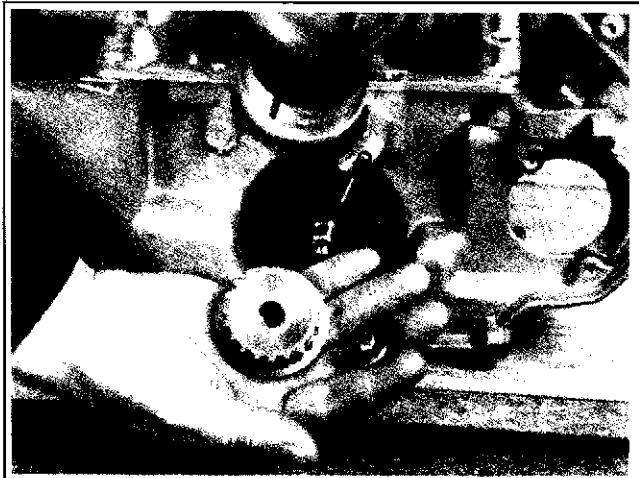
The oil pump is driven by the timing belt on this engine. The flywheel must be removed to gain access to the oil pump. Refer to "Disassembly" Section 9 for details. A service replacement oil pump assembly is available.

To recondition the existing oil pump, proceed as follows:

1. Use the flywheel holding tool to hold sprocket. Then remove retaining screw, washers, and sprocket. A small gear puller may be required to free the sprocket from the shaft. See Figures 10-17 and 10-18.

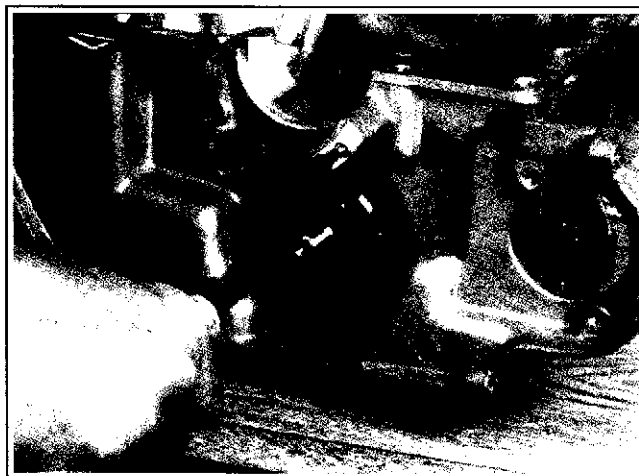


**Figure 10-17. Using Holding Tool to Remove Sprocket.**



**Figure 10-18. Oil Pump Sprocket and Retainer.**

2. Remove the three screws holding the oil pump cover to the lower crankcase half. See Figure 10-19.



**Figure 10-19. Oil Pump Cover Removal.**

3. Remove the cover, wear plate, and the outer rotor and shaft. See Figure 10-20.

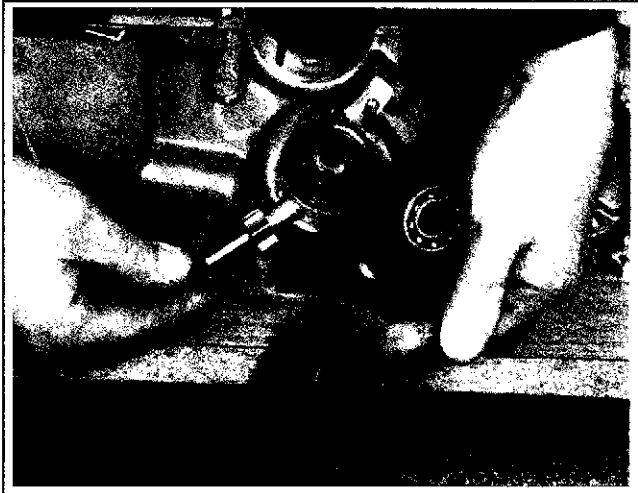


Figure 10-20. Oil Pump Outer Parts.

4. If further disassembly is needed, press the inner ball bearing out of the cover and install a new one in its place. See Figure 10-21.

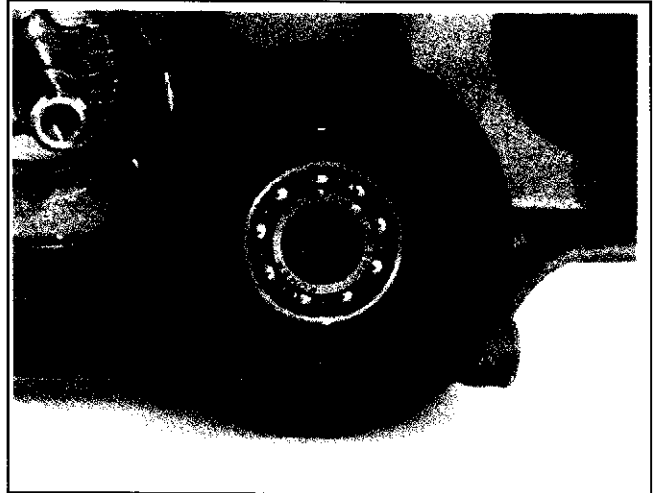


Figure 10-21. Cover With Bearing Installed.

5. Install new oil seal and O-Ring when reassembling the pump.

# Section 11

## Reassembly

### General

**NOTE:** Make sure the engine is assembled using all specified torque values, tightening sequences, and clearances. Failure to observe specifications could cause severe engine wear or damage. Always use new gaskets.

Make sure all traces of any cleaner are removed before the engine is assembled and placed into operation. Even small amounts of these cleaners can quickly break down the lubricating properties of engine oil.

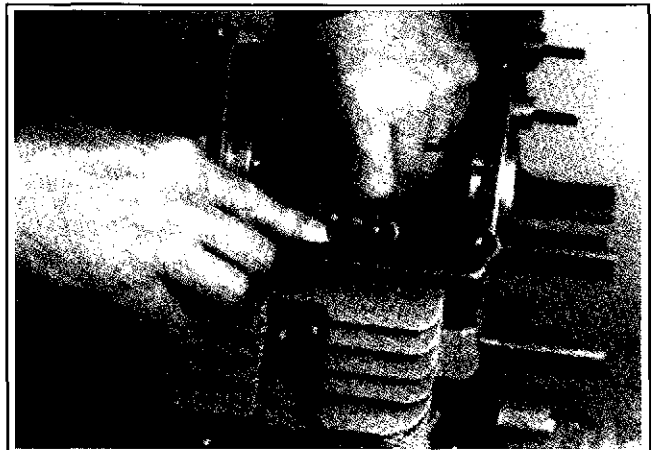
### Typical Reassembly Sequence

The following sequence is suggested for complete engine reassembly. This procedure assumes that all components are new or have been reconditioned, and all component subassembly work has been completed. The sequence may vary to accommodate options or special equipment. Detailed procedures can be found in the subsections following this sequence.

1. Install valve train.
2. Install connecting rods with pistons and rings.
3. Install crankshaft.
4. Install oil pick-up screen.
5. Install oil pressure relief.
6. Install oil pump.
7. Assemble crankcase halves.
8. Stator wire routing.
9. Install crankcase breather.
10. Install oil filter adapter.
11. Install Oil Sentry™ Switch.
12. Install valley baffle and wiring.
13. Install rectifier-regulator.
14. Install governor/camshaft #2 side.
15. Install camshaft #1 side.
16. Install timing belt.
17. Install flywheel.
18. Install ignition modules.
19. Set valve clearance.
20. Install valve cover #1 side.
21. Install valve cover #2 side.
22. Install dipstick.
23. Install spark plugs.
24. Install cylinder side baffles.
25. Install electric starter motor.
26. Install blower housing.
27. Install grass screen or retractable starter.
28. Install carburetor and controls.
29. Install muffler (if so equipped).
30. Install air cleaner.
31. Install fuel tank (if so equipped).
32. Install drain plugs and pre-filled oil filter.
33. Connect spark plug leads.

### Install Valve Train

1. Install the valve seals.
2. Lubricate the valve guides and stems.
3. Turn upper crankcase half upside down in stand block on work bench. Install valves in guides using valve lapping tool. Install valve blocking tools and cover plate, then turn crankcase half over again.
4. Install retainers, springs, and spring caps.
5. Compress valve springs and install valve keepers. See Figure 11-1.



**Figure 11-1. Compress Valve Springs and Install Keepers.**



## Section 11 Reassembly

### Install Connecting Rods with Pistons and Rings.

1. Turn crankcase half upside down again and remove cover plate and valve blocking tools. See Figure 11-2.

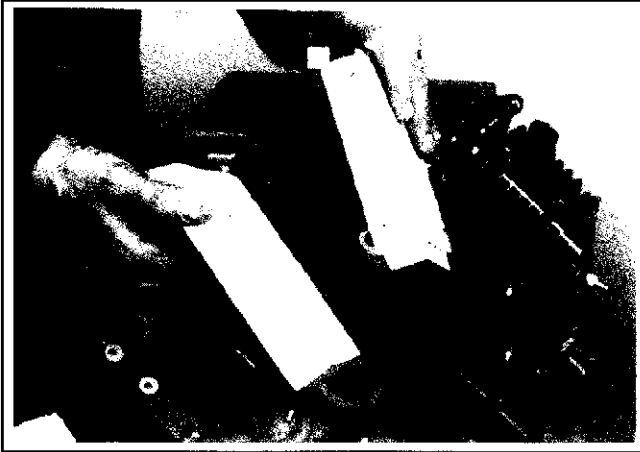


Figure 11-2. Removing Valve Blocking Tool.

NOTE: The cylinders are numbered on the crankcase. Make sure to install piston, connecting rod, and end cap into its appropriate cylinder bore as previously marked at disassembly. Do not mix end caps and connecting rods.

NOTE: Proper orientation of the piston/connecting rod assemblies inside the engine is extremely important. Improper orientation can cause extensive wear or damage.

2. Stagger the piston rings in the grooves until the end gaps are 120° apart. The oil ring rails should also be staggered.
3. Align the match marks and assemble the rod caps to the connecting rods with the screws finger tight.
4. Lubricate cylinder bores, piston, and rings.
5. Compress the rings with piston ring compressor. Push piston through until crown just protrudes from bottom of compressor to pilot inside cylinder bore.
6. Position piston/connecting rod assembly (see "Reconditioning" Section 10) in correct bore with "FLY" mark toward flywheel end and match marks facing outside.

7. Hold the connecting rod in alignment with one hand and "bump" the rod cap with the heel of your other hand to move the piston and rings through the compressor into the cylinder.
8. Repeat procedure with the other piston/rod assembly.

### Install Crankshaft

Install crankshaft assembly (see "Reconditioning" Section 10) as follows. See Figure 11-3.

1. Push the pistons to the top of the cylinder and then remove the rod caps.

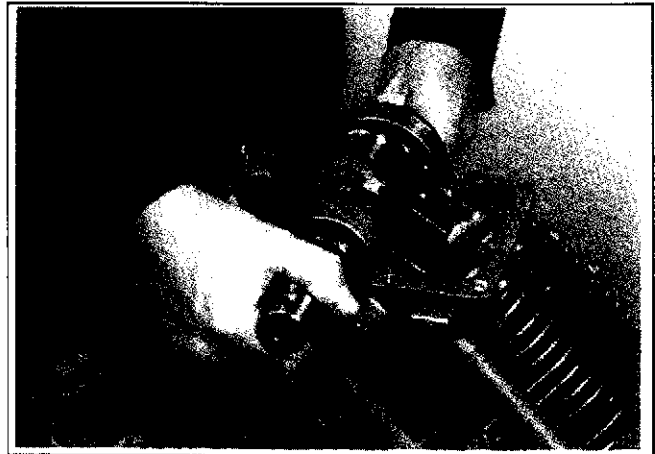


Figure 11-3. Installing Crankshaft Assembly.

2. With the rod journal up, carefully place crankshaft in upper crankcase half.

NOTE: The snap ring on the ball bearing must rest in the groove in the crankcase, aligning hole in the front main bearing must be over the roll pin, and the oil hole must align with groove in crankshaft journal.

3. Pull the connecting rods toward the crankshaft and fit the bearing surfaces to the rod journal on the crankshaft. Lubricate the journal and rod caps with engine oil and reassemble the caps to the appropriate rods. The match marks should be to the outside.
4. Install connecting rod bolts and torque in increments to final torque of **11.3 N·m (100 in. lbs.)**. See Figure 11-4.

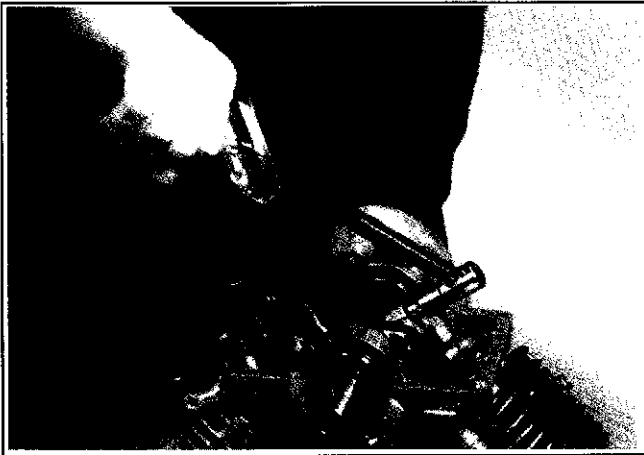


Figure 11-4. Torquing Connecting Rod Bolts.

5. Turn crankshaft to see that it turns freely.
6. Grease lips of front oil seal and use a seal driver to install seal to depth shown in Figure 11-5.

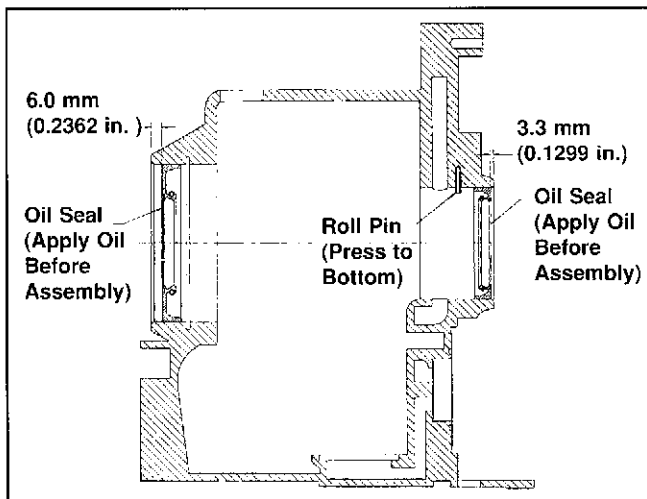


Figure 11-5. Front Oil Seal Depth.

### Install Oil Pick-up Screen

1. Install the oil pick-up filtering screen inside the lower crankcase half. See Figure 11-6.

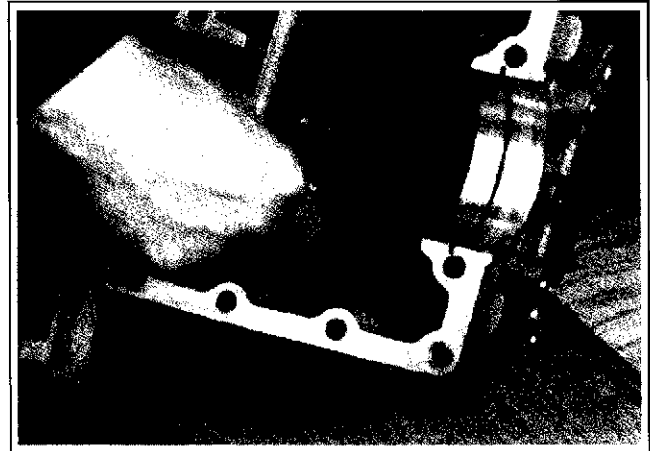


Figure 11-6. Installing Oil Pick-up Screen.

2. Secure the screen with two torx head screws. Torque these to **4.0 N·m (35 in. lbs.)**.

### Install Oil Pressure Relief

1. If they were removed, install the relief valve piston and spring in the lower crankcase half. See Figure 11-7.

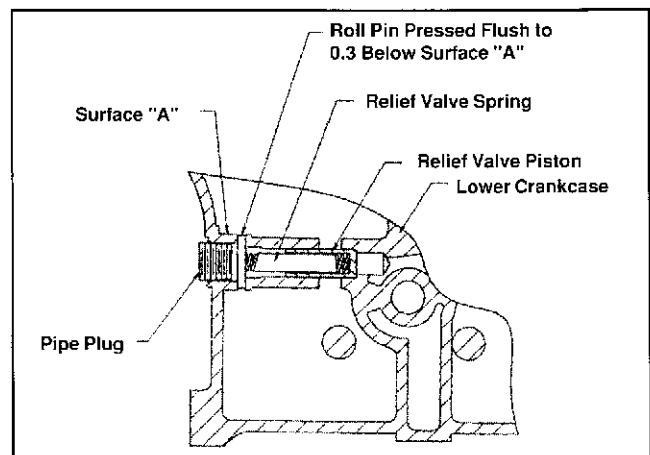


Figure 11-7. Oil Pressure Relief Components.

## Section 11 Reassembly

2. Install the roll pin flush with the surface. See Figure 11-8.

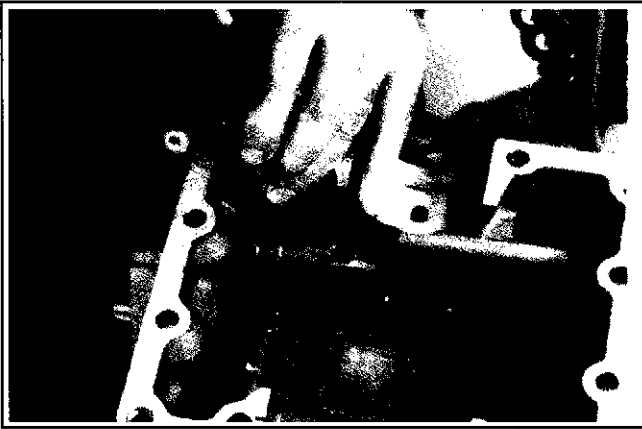


Figure 11-8. Installing Oil Pressure Relief Roll Pin.

3. Apply pipe sealant with Teflon™ to the threads and install the oil pressure relief valve pipe plug. Torque the plug to **11.3 N·m (100 in. lbs.)**. See Figure 11-9.



Figure 11-9. Installing Pipe Plug.

### Install Oil Pump

1. Install a new O-Ring inside the crankcase. See Figure 11-10.

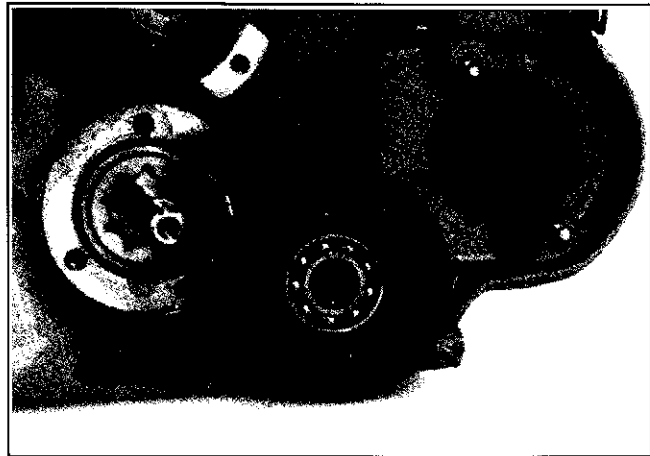


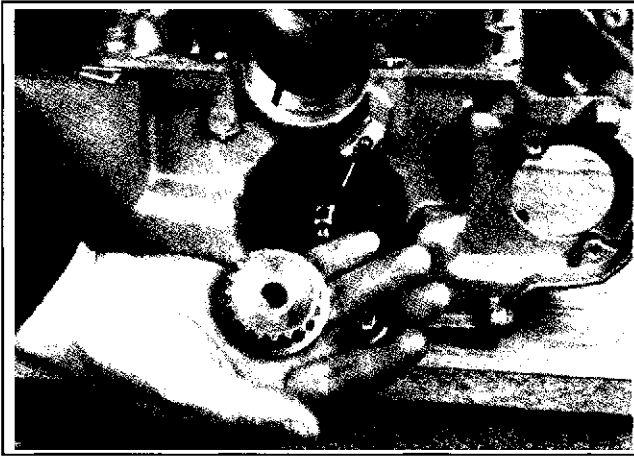
Figure 11-10. Installing O-Ring Inside Crankcase.

2. Install new or reconditioned oil pump assembly (refer to "Reconditioning" Section 10).
3. Secure the oil pump cover to the lower crankcase with the three hex. flange screws. Tighten these to **7.3 N·m (65 in. lbs.)** torque. See Figure 11-11.



Figure 11-11. Securing Oil Pump Cover to Crankcase.

4. Install the oil pump drive gear on pump shaft. See Figure 11-12.



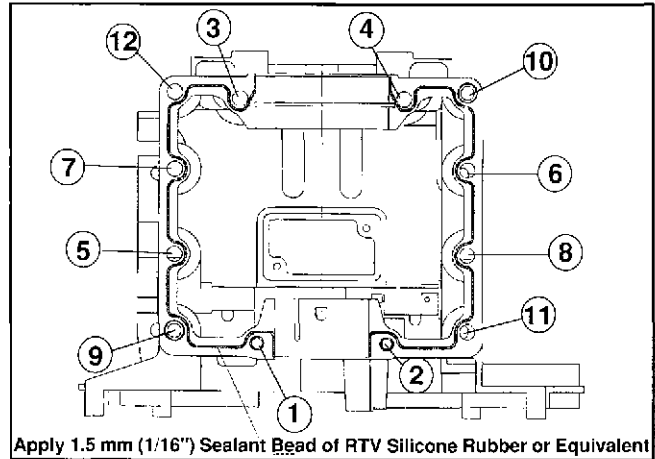
**Figure 11-12. Oil Pump Drive Gear Parts.**

5. Secure the drive gear with a wave washer, flat washer, lock washer and hex. flange screw. Torque to **9.9 N·m (88 in. lbs.)**.

### Assemble Crankcase Halves

RTV silicone sealant is used as a gasket between the crankcase halves. Refer to the chart on page 2.2 of "Special Tools" Section 2 of this manual for a listing of approved sealants. Always use fresh sealant. Using outdated sealant can result in leakage.

1. Prepare the sealing surfaces of the crankcase halves as directed by the sealant manufacturer.
2. Check to make sure that there are no nicks or burrs on the sealing surfaces of the halves.
3. Apply a 1.5 mm (1/16") bead of silicone sealant to the surface of the lower crankcase half in pattern shown in Figure 11-13.

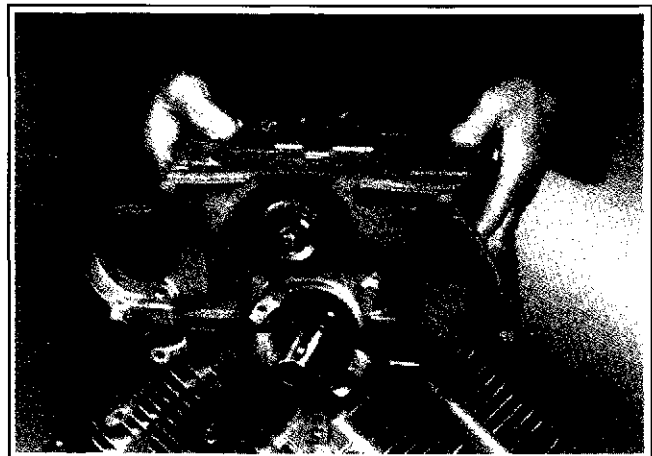


Apply 1.5 mm (1/16") Sealant Bead of RTV Silicone Rubber or Equivalent

**Figure 11-13. Crankcase Sealant Pattern and Fastener Torque Sequence.**

4. Turn lower crankcase half upside down and carefully place on the upper half as shown in Figure 11-14.

Make sure the snap ring on the ball bearing fits into the groove on the PTO end of the crankcase halves.



**Figure 11-14. Install Lower Crankcase To Upper Half.**

5. Loosely install the crankcase fasteners in proper position but do not tighten. The two 70 mm long go in positions marked 1 and 2; the two 115 mm long go into positions marked 3 and 4 on the PTO side; and the eight 40 mm long go into the remaining side holes. See Figure 11-13.

## Section 11 Reassembly

6. Lay a straight edge or surface plate vertically across the bosses on the PTO face of the crankcase to check alignment between the upper and lower halves. Tap or shift the lower half as necessary to bring it into correct alignment.
7. Torque all crankcase retaining fasteners to **24.4 N·m (216 in. lbs.)** in the sequence shown in Figure 11-13.



Figure 11-15. Tighten Crankcase Halves to Torque.

### Stator Wire Routing

1. Route wiring so that leads are in 10 o'clock position. See Figure 11-16.

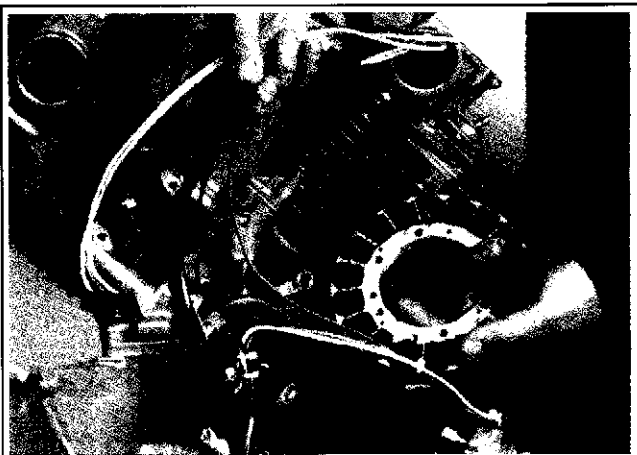


Figure 11-16. Route Wiring to Stator.

2. Install the two stator mounting screws but do not tighten them at this time. The stator will have to be removed later when installing the timing belt. See Figure 11-17.



Figure 11-17. Loosely Install Stator Mounting Screws.

### Install Crankcase Breather

1. Install a new breather grommet in crankcase. See Figure 11-18.

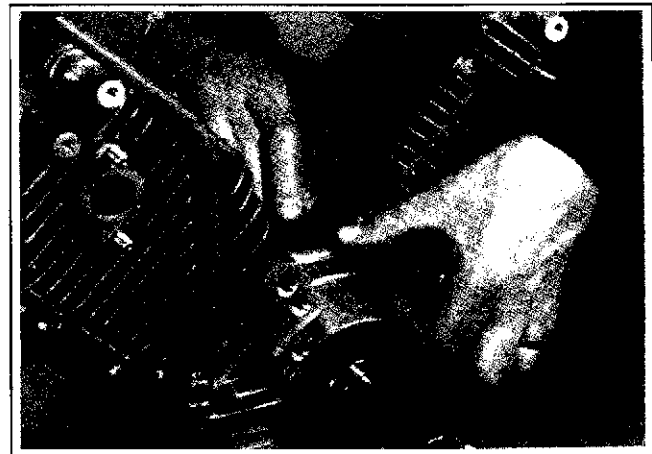
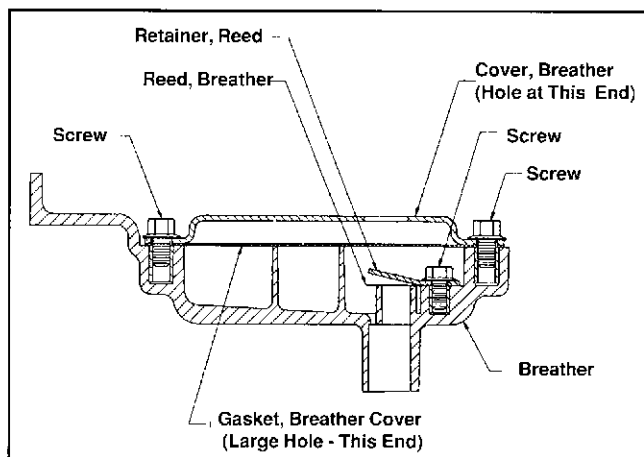


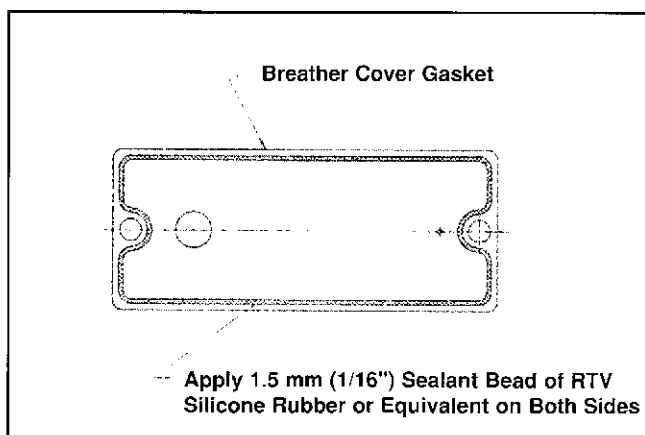
Figure 11-18. Installing New Grommet in Crankcase.

2. Install breather reed and reed retainer in breather housing and secure with hex. flange screw. Tighten screw to **4.0 N·m (35 in. lbs.)** torque. See Figure 11-19.



**Figure 11-19. Crankcase Breather Components.**

3. Examine the new replacement breather cover gasket. If it has silicone beads imprinted on the surfaces, go to step 8. If it does not have beads, follow steps 4-7.
4. RTV silicone sealant is used on both sides of the breather cover gasket. Refer to page 2.2 for a listing of approved sealants. Always use fresh sealant. Using outdated sealant can result in leakage.
5. Prepare the sealing surfaces of the breather cover and breather as directed by the sealant manufacturer.
6. Check to make sure that there are no nicks or burrs on the sealing surfaces.
7. Apply 1.5 mm bead of silicone sealant to breather cover gasket (both sides). See Figure 11-20.



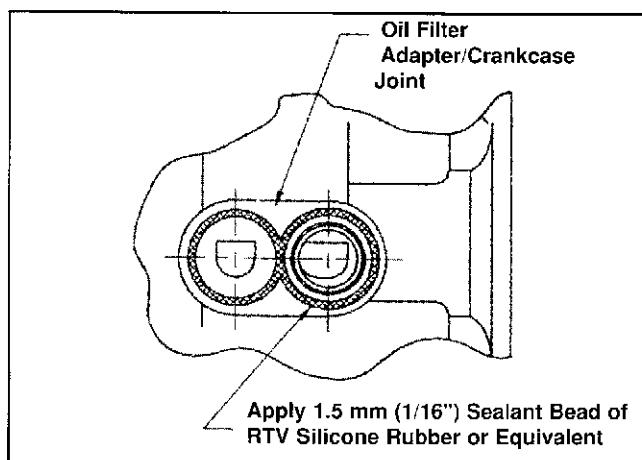
**Figure 11-20. Sealant Pattern For Breather Cover Gasket.**

8. Position new breather cover gasket with large hole toward the flywheel end of the engine. See Figure 11-19.
9. Position the breather cover with the hole toward PTO end. Install the two cover mounting screws and tighten these to **5.6 N·m (50 in. lbs.)** torque.
10. Apply lubricant to nipple on bottom of breather to aid insertion into the grommet.
11. Install breather assembly into grommet and press it down.
12. Install breather retaining screws and tighten to **4.0 N·m (35 in. lbs.)** torque. Top tank models have a wire retaining clip under the breather screw on the #1 side.

### Install Oil Filter Adapter

RTV silicone sealant is used as a gasket between the oil filter adapter and the crankcase. Refer to page 2.2 for a listing of approved sealants. Always use fresh sealant. Using outdated sealant can result in leakage.

1. Prepare the sealing surfaces of the crankcase and oil filter adapter as directed by the sealant manufacturer.
2. Check to make sure that there are no nicks or burrs on the sealing surfaces.
3. Apply 1.5 mm bead of silicone sealant to crankcase/oil filter adapter joint. See Figure 11-21.



**Figure 11-21. Sealant Pattern Oil Filter Adapter/Crankcase Joint.**

## Section 11

### Reassembly

4. Install oil filter adapter. Install flat washer and turn nipple into adapter and crankcase. Torque nipple to **40.7 N·m (30 ft. lbs.)**.

#### Install Oil Sentry™ Switch (If So Equipped)

1. Apply pipe sealant with Teflon™ to the threads of the switch. Hand start the Oil Sentry™ switch into the oil filter adapter.
2. Torque the Oil Sentry™ switch to a maximum of **3.4 N·m (30 in. lbs.)** as shown in Figure 11-22. **Do not overtighten the switch. The switch has pipe thread (tapered) and it will crack the adapter if overtightened.**
3. Connect the wires to the Oil Sentry™.

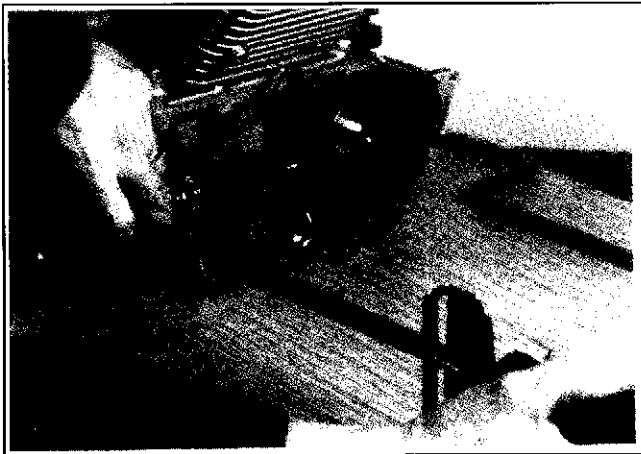


Figure 11-22. Torque Oil Sentry™ Switch.

#### Install Valley Baffle and Wiring.

1. Before installing the valley baffle (see Figure 11-23), carefully route wiring as follows:
  - a. Stator wiring harness must be between where valley baffle mounts.
  - b. Ground wire attaches to lower mounting screw of baffle.
  - c. Rectifier-regulator feeds through cutout.

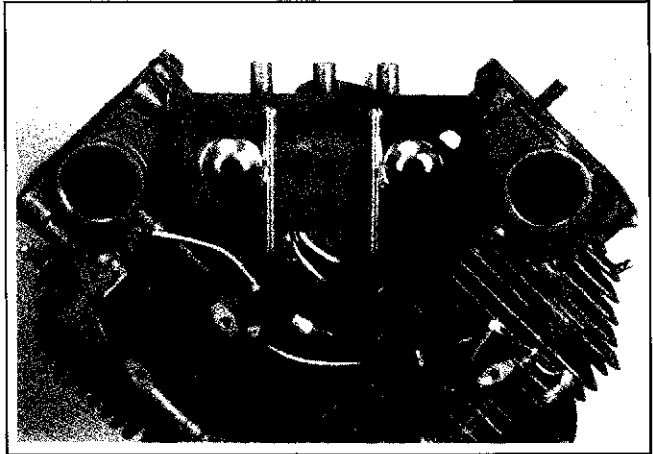


Figure 11-23. Valley Baffle Installed. Note Wiring.

#### Install Rectifier-Regulator

1. On engines equipped with top-mounted fuel tanks, install the spacer and rectifier-regulator. See Figure 11-24.

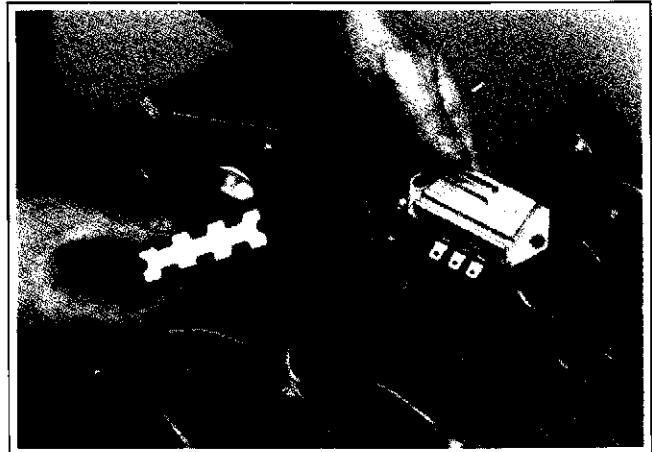


Figure 11-24. Spacer and Rectifier-Regulator (Top-Mount Fuel Tank Units Only).

2. Secure rectifier-regulator to valley baffle with two screws. See Figure 11-25.

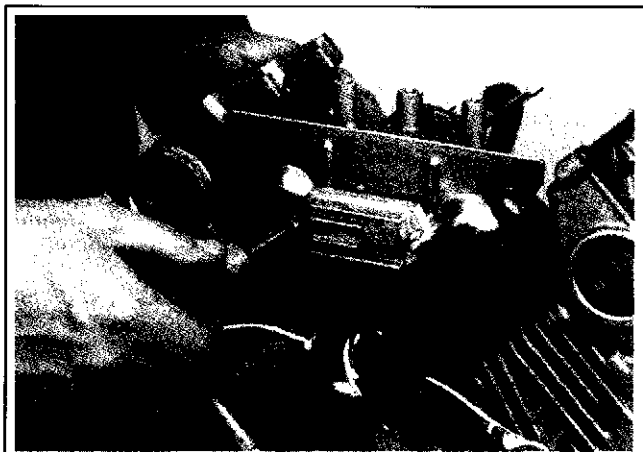


Figure 11-25. Rectifier-Regulator Installed On Valley Baffle.

3. Connect terminal block to the rectifier-regulator. See Figure 11-26.

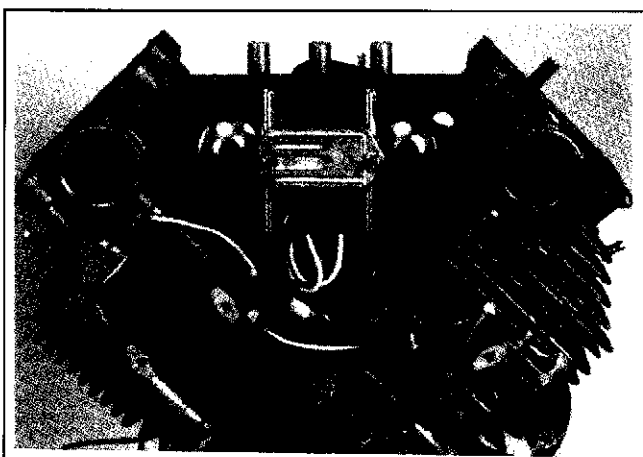


Figure 11-26. Rectifier-Regulator Connected.

4. Route wire from breather to backside (PTO end) of baffle and attach wire clip to baffle with hex. flange screw.

### Install Governor/Camshaft #2 Side

1. Slide governor cross shaft in from inside of valve box. See Figure 11-27.

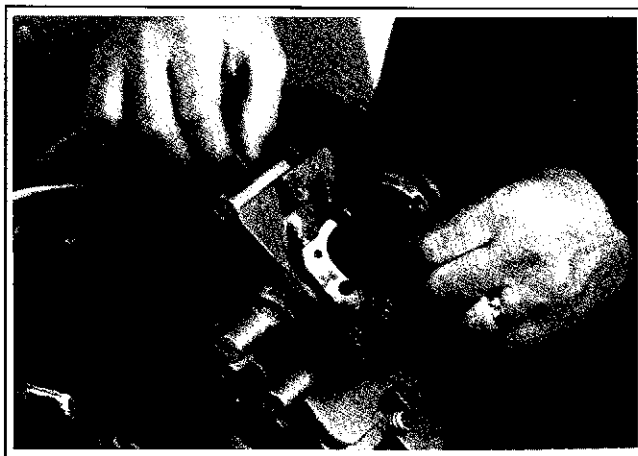


Figure 11-27. Install Cross Shaft and Yoke.

2. Secure yoke with two allen head screws. See Figure 11-27.
3. Lubricate the rocker arm shaft. Install rocker arm assembly in #2 chamber and torque retaining screws to **4.0 N·m (35 in. lbs.)**.
4. Grease lip on new camshaft oil seals (both sides, as installed in Section 10).
5. Position governor assembly inside valve chamber. Insert camshaft/belt sprocket through seal, governor, and rocker arms. See Figure 11-28.



Figure 11-28. Installing Camshaft Through Governor.



## Section 11

### Reassembly

6. Turn the camshaft until the hole aligns with the matching hole in the governor body.
7. Insert new coiled spring pin in the holes and drive in with a punch until flush with the governor body. See Figure 11-29.



Figure 11-29. Driving Coiled Spring Into Position in Governor.

#### Install Camshaft #1 Side

1. Lubricate the rocker arm shaft. Install rocker arm assembly into position in chamber on the #1 side. Torque screws to 4.0 N·m (35 in. lbs.). See Figure 11-30.

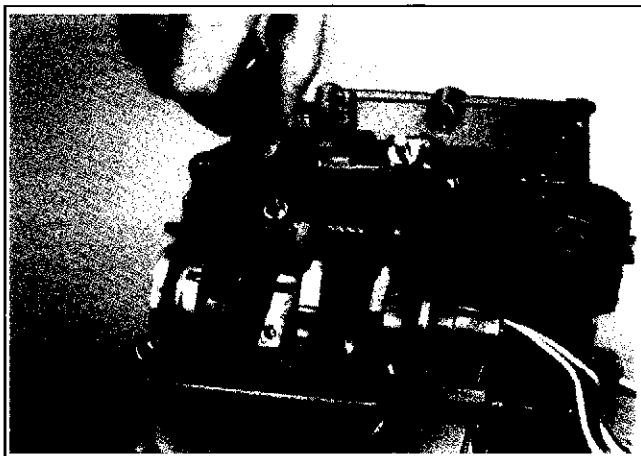


Figure 11-30. Installing Rocker Arm Assembly on #1 Side.

3. Apply a small amount of grease to lip of oil seal.
4. Hold the thrust washer inside the rocker chamber and insert the #1 side camshaft/belt sprocket through the seal, thrust washer, and rocker arms.

5. Install the C-clip in groove to hold camshaft in place.
6. Leave covers off until later.

#### Install Timing Belt

1. Install the flywheel key into the keyway of the crankshaft. See Figure 11-31. Make sure that key is properly seated and parallel with shaft.

NOTE: Make sure flywheel key is installed properly in the keyway. The flywheel can become cracked or damaged if the key is not installed properly in the keyway.

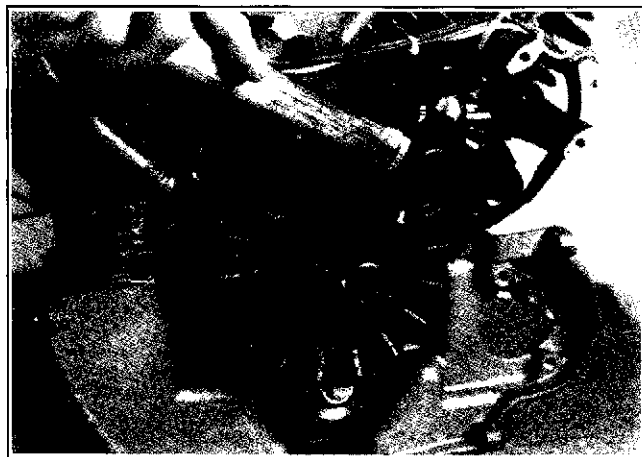
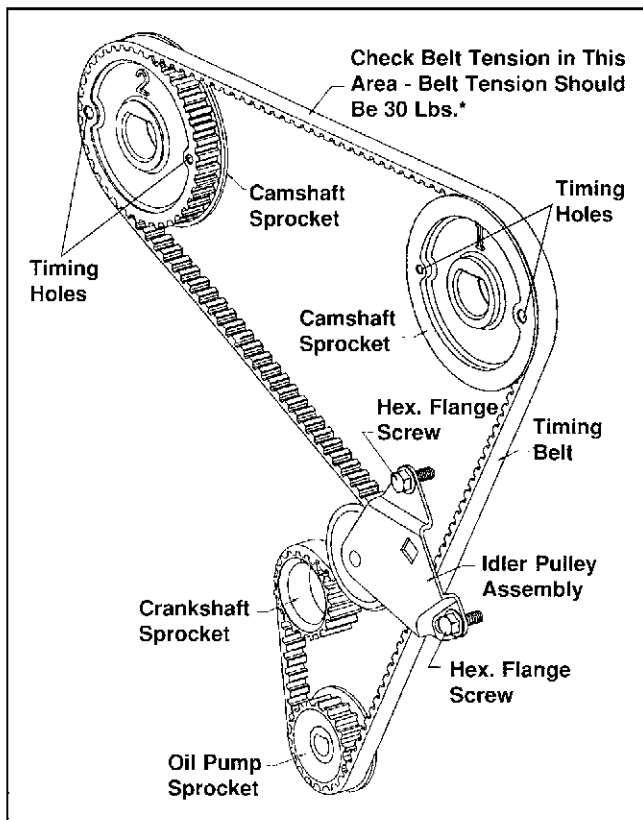


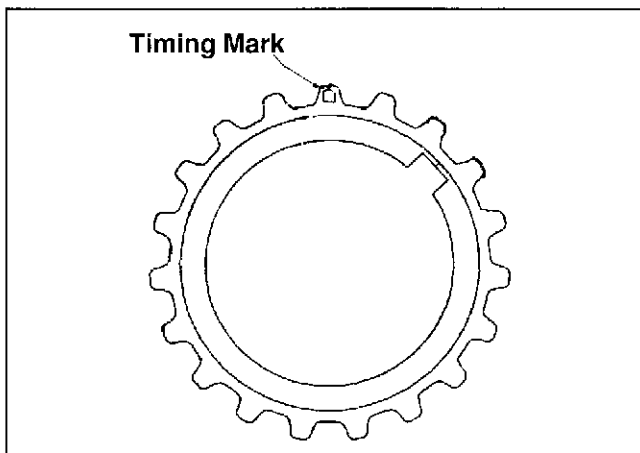
Figure 11-31. Installing Key In Crankshaft.

2. Remove the two screws and remove the stator to allow installation of the timing belt over the crankshaft sprocket.
3. Rotate camshafts until timing holes in sprockets are horizontal and numbers are at the top. See Figure 11-32.



**Figure 11-32. Timing Belt Detail.**

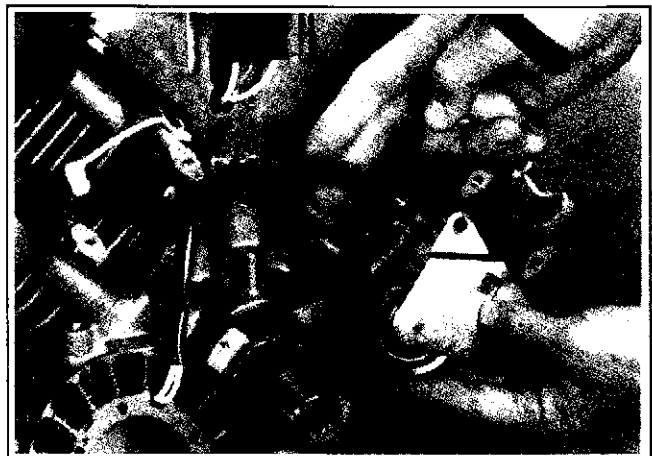
3. Insert pins of camshaft timing tool into timing holes in sprockets. See "Special Tools" Section 2.
4. Set the engine to top dead center (TDC) on the #1 cylinder. AT TDC, the third tooth counterclockwise from the keyway in crankshaft will be lined up with the point on crankcase. See Figure 11-33.



**Figure 11-33. Setting #1 Cylinder at Top Dead Center.**

\*Cold Engine

5. Slide the crankshaft holding tool onto the crankshaft with the keyway over the flywheel key and the mounting tab toward crankcase. Secure the mounting tab to lower stator mounting boss.
6. Route timing belt along the left side of crankshaft and oil pump sprockets. See Figure 11-32.
7. Route timing belt counterclockwise around remaining sprockets as shown in Figure 11-32. If belt has arrows on it, they should point in the direction of rotation (clockwise).
8. With idler pulley assembly loose, route the belt around the idler sprocket. See Figure 11-34. Then install idler assembly as follows:
  - a. Start top screw of assembly into crankcase first.
  - b. Using 3/8" drive extension on a torque wrench, place extension in square slot in plate for leverage.
  - c. Apply leverage and install the lower screw.



**Figure 11-34. Routing Timing Belt Around Idler Sprocket.**

## Section 11 Reassembly

- Adjust timing belt tension (cold engine) by applying **3.4/4.5 N·m (30/40 in. lbs.)** torque in counterclockwise direction. Tighten idler assembly screws to **7.3 N·m (65 in. lbs.)**, starting with the lower screw. See Figures 11-32 and 11-35.

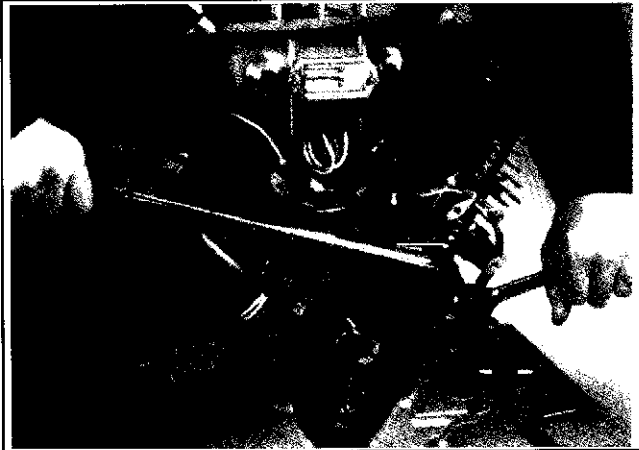


Figure 11-35. Adjusting Timing Belt Tension.

- Reinstall the stator and torque the mounting screws to **4.0 N·m (35 in. lbs.)**.
- Check to make sure all wiring is routed away from the timing belt to prevent cutting wires.

### Install Flywheel

**⚠ WARNING: Damaging Crankshaft and Flywheel Can Cause Personal Injury!**

*Using improper procedures to install the flywheel can crack or damage the crankshaft and/or flywheel. This not only causes extensive engine damage, but can also cause personal injury, since broken fragments could be thrown from the engine. Always observe and use the following precautions and procedures when installing the flywheel.*

NOTE: Before installing the flywheel make sure the crankshaft taper and flywheel hub are clean dry, and completely free of lubricants. The presence of lubricants can cause the flywheel to be overstressed and damaged when the retaining screw is torqued to specifications.

NOTE: Always use a flywheel strap wrench or holding tool to hold the flywheel when tightening the flywheel fastener. Do not use any type of bar or wedge to hold the flywheel, as component damage and personal injury could result.

- Install tension spring. See Figure 11-36.

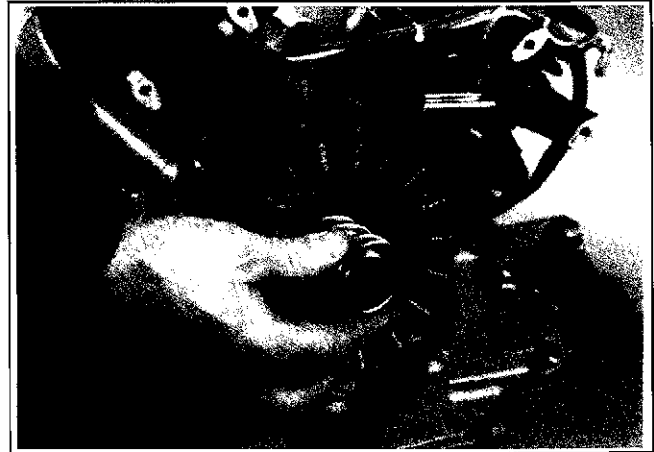


Figure 11-36. Installing Tension Spring.

- Install flywheel, drive cup (if engine has retractable starter), washer, and retaining screw.
- Use a flywheel strap wrench or flywheel holding tool to hold the flywheel. Torque retaining screw to **66.4 N·m (49 ft. lbs.)**. See figure 11-37.

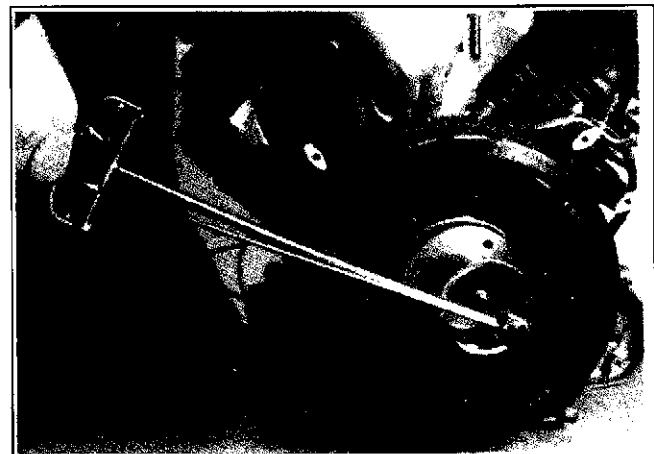


Figure 11-37. Installing Flywheel Fastener.

\*Cold Engine

### Install Ignition Modules

1. Turn flywheel so ignition magnet is away from the module positions.
2. Install ignition module for the #2 side with the kill terminal toward the cylinder. The #1 side should have the kill terminal facing away from the cylinder. Pull the modules away from the flywheel and snug the screws to hold them in position.
3. Rotate the flywheel to position the magnet directly under an ignition module.
4. Insert a **0.25 mm (0.010 in.)** flat feeler gauge or shim stock between the magnet and ignition module (see Figure 11-38). Loosen the screws enough to allow the magnet to pull the module down against the feeler gauge.
5. Torque the two hex. flange screws to **4.0/6.2 N·m (35/55 in. lbs.)**.
6. Repeat steps 3 through 5 for the other ignition module.
7. Rotate the flywheel back and forth checking for clearance between the magnet and ignition modules. Make sure the magnet does not strike the modules. Check the gap with a feeler gauge and readjust if necessary. Final Air Gap: **0.20/0.30 mm (0.008/0.012 in.)**.
8. Connect the kill leads to the terminals.



Figure 11-38. Adjusting Air Gap of Ignition Modules.

### Set Valve Clearance

1. Turn flywheel clockwise to TDC on the #1 side.
2. Loosen locking nut and screw and insert feeler gauge blade. Clearance should be **0.013/0.064 mm (0.0005/0.0025 in.)** for the intake valve and **0.076/0.127 mm (0.0030/0.0050 in.)** for exhaust valve. Adjust screw in or out until it is the correct clearance, then tighten locking nut. See Figure 11-39.

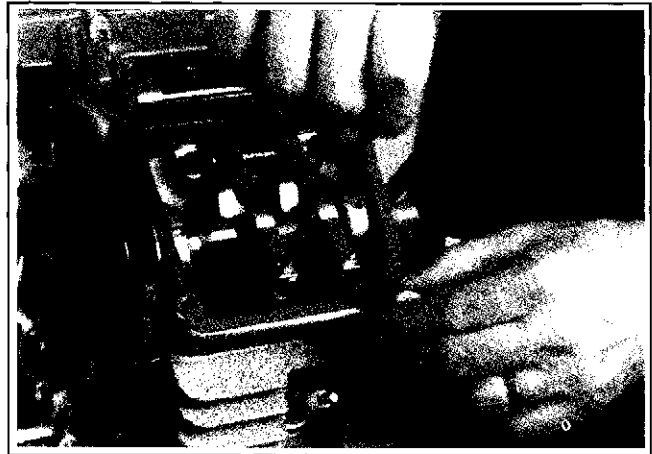


Figure 11-39. Adjusting Valve Clearance. (#1 Shown).

3. Turn flywheel clockwise 270° until #2 cylinder is at TDC.
4. Repeat clearance checks and adjustment procedure from step 2 on #2 side. Set this side to same clearance **0.013/0.064 mm (0.0005/0.0025 in.)** for the intake valve and **0.076/0.127 mm (0.0030/0.0050 in.)** for the exhaust valve.

## Section 11 Reassembly

### Install #1 Side Valve Cover

1. Install new cover gasket on #1 valve chamber.
2. Install valve cover and insert the four fasteners.\*  
Note that the lifting strap is usually installed in the lower front position. See Figure 11-40.

\*NOTE: On engines with top-mounted fuel tanks, the top two are fuel tank mounting studs. See Figure 11-42.



Figure 11-40. Installing Valve Cover - #1 Side.

3. Torque the fasteners to **5.6 N·m (50 in. lbs.)** in the sequence shown in Figure 11-41.

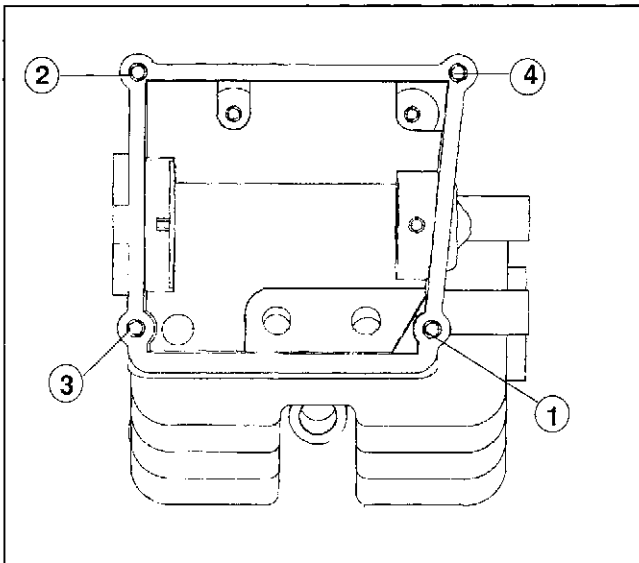


Figure 11-41. Valve Cover Tightening Sequence - #1 Side.

### Install #2 Side Valve Cover

1. Install new cover gasket on #2 valve chamber.
2. Install valve cover and insert the six fasteners.\*

\*NOTE: On engines with top-mounted fuel tanks, the top three are fuel adapter studs. See Figure 11-42.

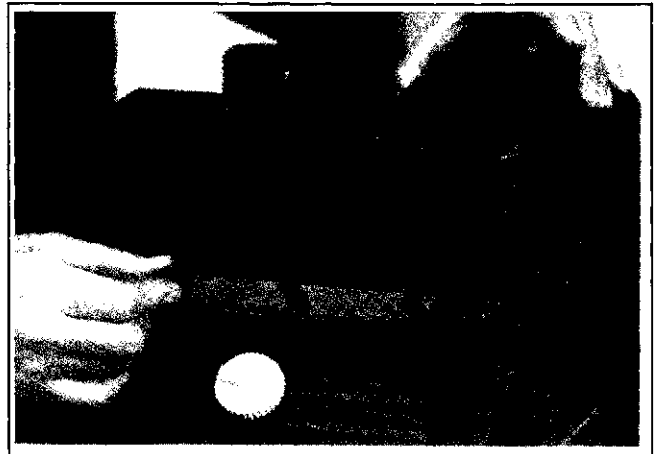


Figure 11-42. Stud Location on Top Mounted Tank - #2 Side.

3. Torque the fasteners to **5.6 N·m (50 in. lbs.)** (see Figure 11-43) in the sequence shown in Figure 11-44.

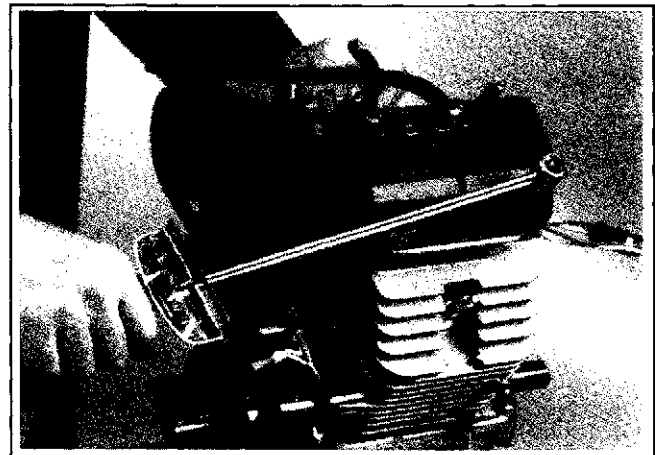


Figure 11-43. Installing Valve Cover - #2 Side.

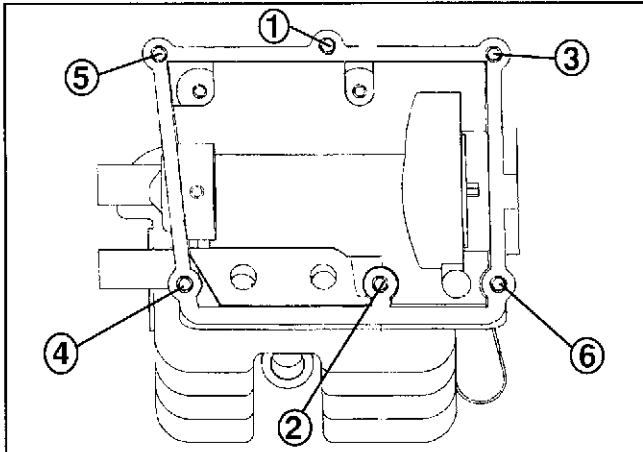


Figure 11-44. Valve Cover Tightening Sequence - #2 Side.

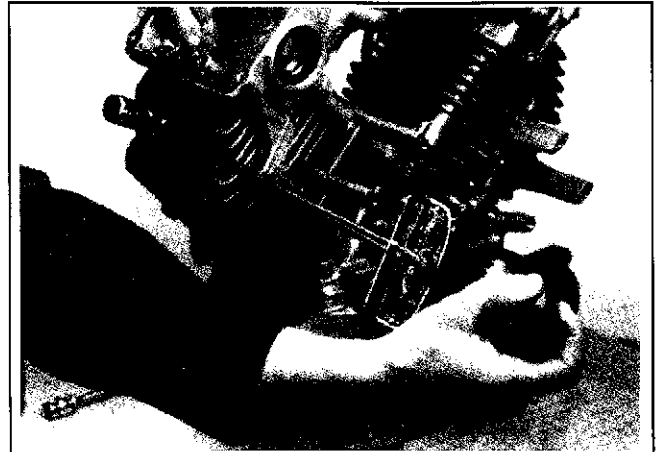


Figure 11-46. Torque Spark Plugs.

3. Leave spark plug leads disconnected until later.

### Install Dipstick

1. Reinstall dipstick in tube on PTO end. See figure 11-45.



Figure 11-45. Installing Dipstick in Tube.

### Install Spark Plugs

1. Install new spark plugs after setting gap at **0.76 mm (.030 in.)**.
2. Tighten plugs to **24.4/29.8 N·m (18/22 ft. lbs.)** with torque wrench. See Figure 11-46.

### Install Cylinder Side Baffles

1. Install the #2 cylinder side baffle and secure with one hex. flange screw. Leave screw slightly loose at this time. See Figure 11-47.

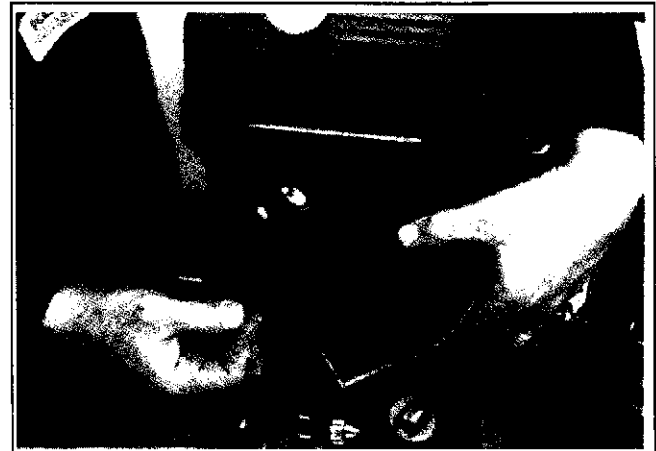


Figure 11-47. Installing #2 Side Baffle.

2. Install the #1 cylinder side baffle and secure with two hex. flange screws (which also mounts the cranking solenoid on engines so equipped). Leave screws slightly loose at this time.

## Section 11 Reassembly

3. Install wiring connector to #1 cylinder side baffle with two hex. flange screws. See Figure 11-48.

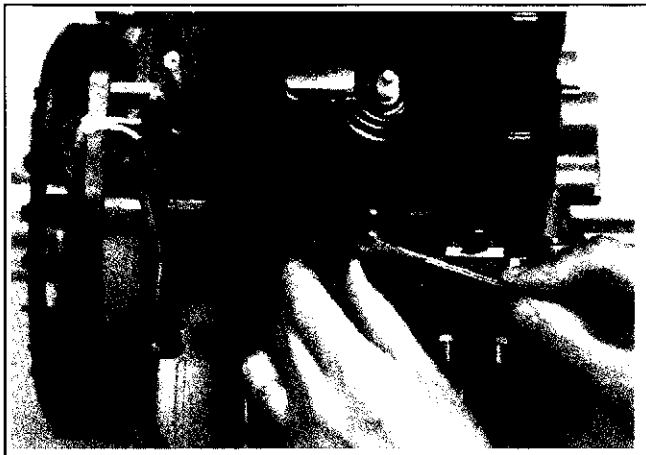


Figure 11-48. Installing Wiring Connector.

### Install Electric Starter Motor

1. Install electric starter motor by inserting thru bolts into flange of lower crankcase. See Figure 11-49.

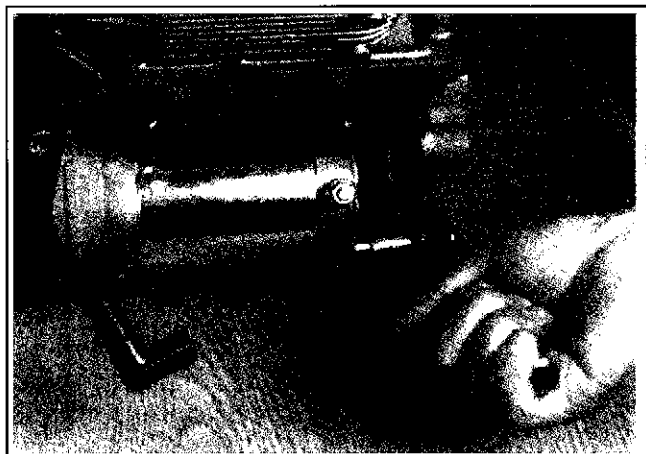


Figure 11-49. Installing Electric Starter Motor.

2. Tighten bottom bolt first, then the top bolt.

### Install Blower Housing

1. Install the blower housing on the engine. See Figure 11-50.

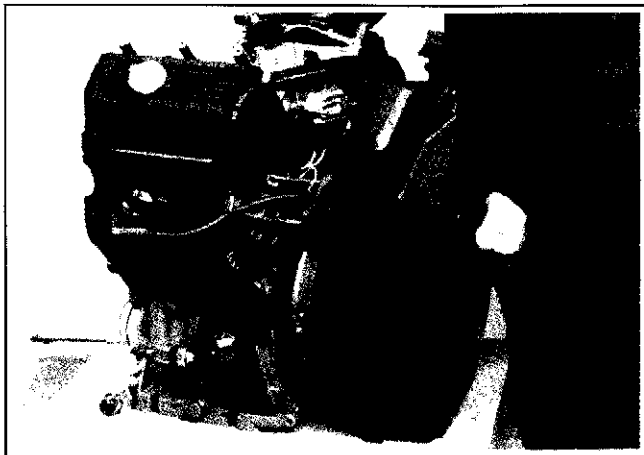


Figure 11-50. Installing Blower Housing.

2. Secure the blower housing to crankcase. The two shorter screws are installed at the top positions, and the four longer screws go in the middle and bottom positions. Leave screws slightly loose to shift housing. See Figure 11-51.

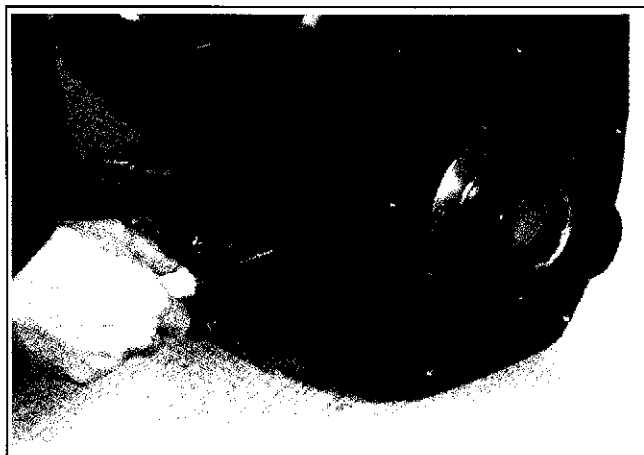


Figure 11-51. Securing Blower Housing Screws.

3. Install hex. flange nuts in recesses at top front of blower housing.

### Install Grass Screen or Retractable Starter

1. If the engine does not have a retractable starter, snap grass screen in place or attach to flywheel fan with appropriate hardware.
2. Position the retractable starter with handle in same position as removed.
3. Install the five retaining screws but leave loose until step 4 is complete.
4. Pull the starter handle out until the pawls engage in the drive cup. Hold the handle in this position and tighten the screws securely. See Figure 11-52.



Figure 11-52. Installing Retractable Starter.

### Install Carburetor and Controls

**⚠ WARNING: Explosive Fuel!**

Gasoline may be present in the carburetor and fuel system. Gasoline is extremely flammable and its vapors can explode if ignited. Keep sparks and other sources of ignition away from the engine.

1. Install governor spring in hole locations marked during disassembly. Spring coils should be closest to the pivot lever.
2. Connect governor link to pivot lever and lock with bushing clip.
3. Reattach choke link to choke lever and carburetor.
4. Connect throttle link and linkage spring to pivot lever and lock with bushing clip.

5. Hold the carburetor/control bracket/governor lever assembly just above the engine and reconnect the solenoid leads.
6. Slide a new carburetor gasket onto the manifold studs followed by the carburetor, new elbow gasket, and the elbow.
7. Slide the governor lever onto the governor shaft but do not tighten it.
8. Mount throttle control bracket to crankcase with four hex. flange screws, and then tighten all baffles and blower housing screws.
9. On standard models, apply Loctite® to the bottom threads of the air cleaner stud and reinstall it in the top of the crankcase.
10. Remove the hex. flange nuts from the stud and install them on the manifold studs to secure the carburetor. Torque the nuts to **9.9 N·m (88 in. lbs.)**.
11. Feed breather hose through control bracket and carefully attach lower end to breather cover. Be sure flanges overlap cover hole for a positive seal. Reattach the upper end to flange on the air intake elbow and secure it with the hose clamp.
12. Connect the fuel line to carburetor and secure with a hose clamp. See Figure 11-53.

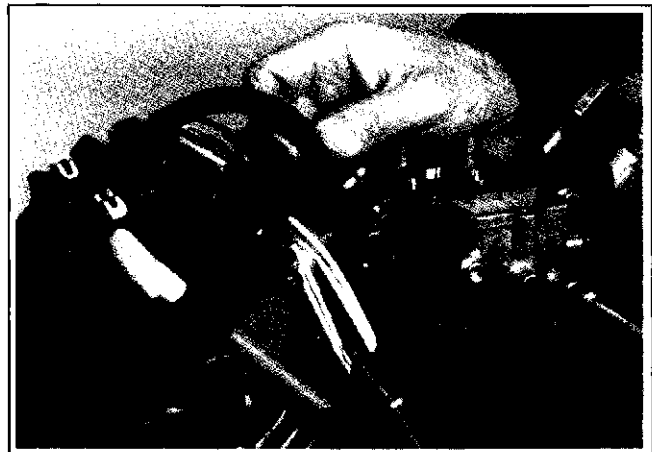


Figure 11-53. Connecting Fuel Line To Carburetor.

3. Insert a small nail through hole in end of governor shaft. Reset governor by rotating cross shaft counterclockwise and pushing governor lever toward control bracket, then tightening the screw and nut.



## Section 11 Reassembly

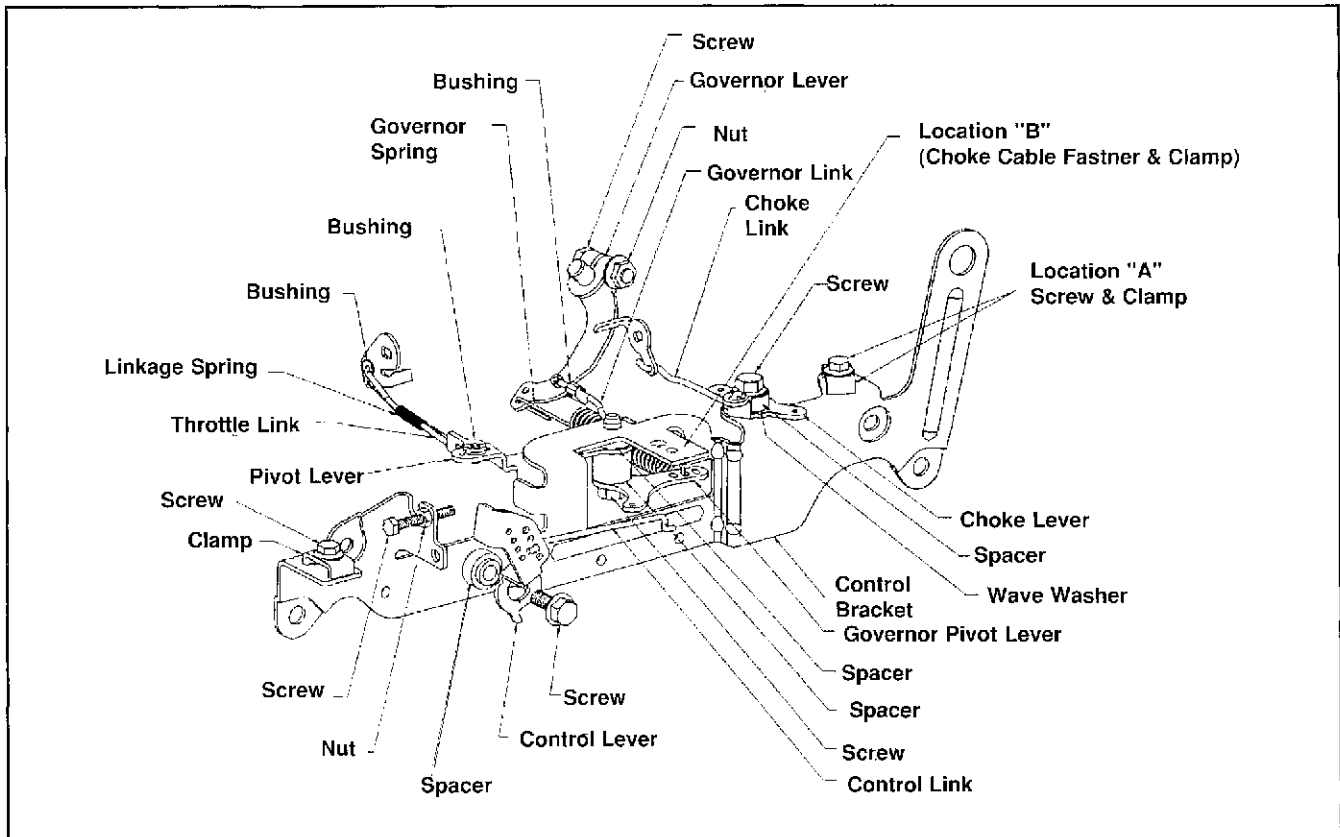


Figure 11-54. Standard Throttle Control Detail.

### Install Muffler

1. Install new exhaust gaskets on both ports.
2. Install muffler on studs and secure with four nuts. See Figure 11-55.

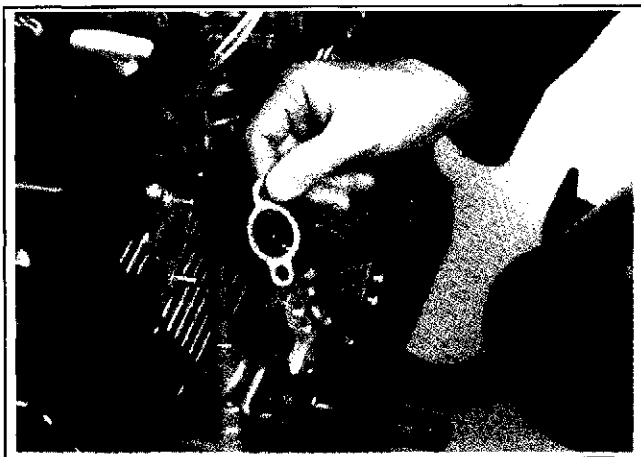


Figure 11-55. Installing Exhaust Gasket and Muffler.

### Install Air Cleaner

1. Install a new base plate gasket and base plate. Secure to the carburetor with three hex. flange screws tightened to **9.9 N·m (88 in. lbs.)** torque. See Figure 11-56. Install new seals on base plate studs (one long seal on top tank version).

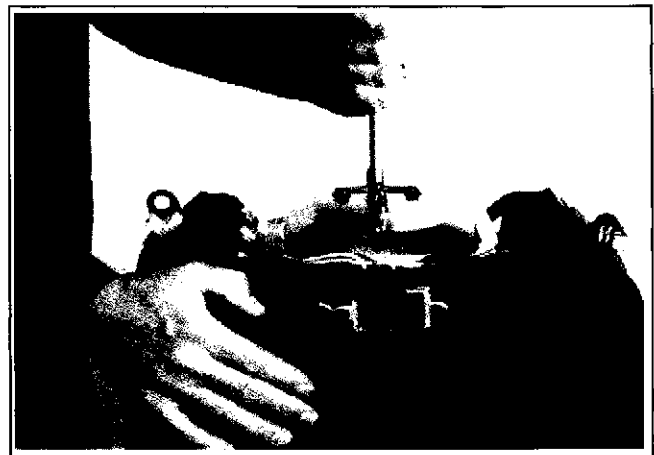


Figure 11-56. Install Air Cleaner Base Plate (Std. Shown).

2. Install precleaner and paper element.
3. Install inner cover and secure with two wing nuts (one on top tank type cleaner).\* See Figure 11-57.



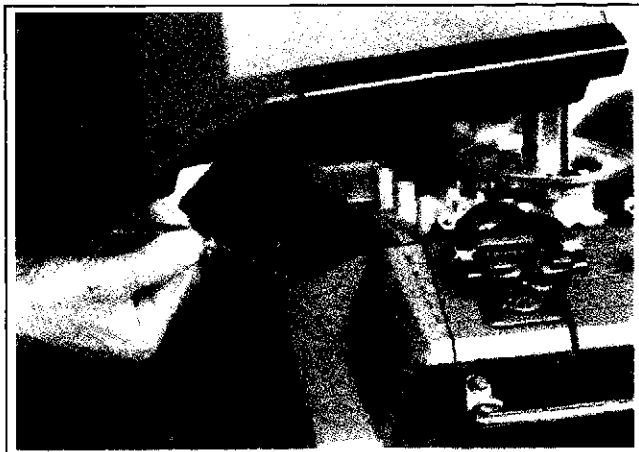
**Figure 11-57. Installing Inner Cover Wing Nut (Top Tank Shown).**

4. Install air cleaner cover and secure with retaining knob (standard type only--on top tank type install cover only after tank is installed).

NOTE: Refer to Section 4 for air cleaner components.

### Install Fuel Tank (Top Mounted)

1. Install hose clamp on fuel line. Connect line to fitting on fuel shut-off valve and then slide clamp over fitting and release. See Figure 11-58.



**Figure 11-58. Connecting Fuel Line to Shut-Off Valve (Top Mounted Tank).**

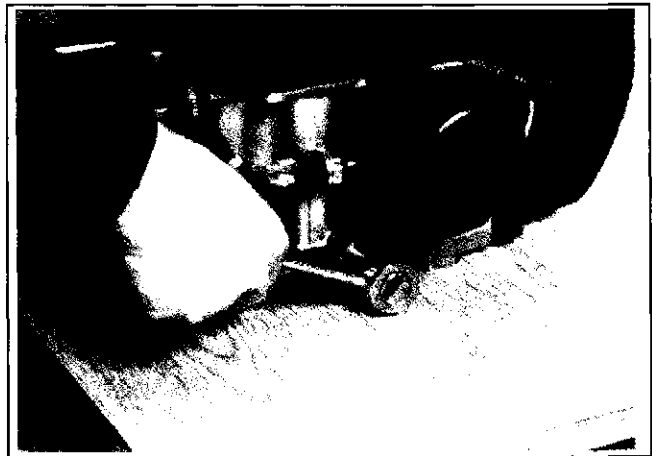
2. Place tank on top of engine and slide it into position back toward PTO end.

\*Be sure grommet aligns with hole in base (std. type).

3. Align tank over stud holes then install and secure with five hex. flange screws.
4. Install air cleaner cover after top tank is secured.

### Install Drain Plugs and Oil Filter

1. Install oil drain plugs and securely tighten. See Figure 11-59.



**Figure 11-59. Reinstalling Oil Drain Plugs.**

2. Prefill oil filter following instructions in Section 6.
3. Install prefilled oil filter. Turn clockwise until tight.
4. Add oil to bring level up to full mark on dipstick.

### Connect Spark Plug Leads

1. Connect the leads to the spark plugs. See Figure 11-60.



**Figure 11-60. Connect Spark Plug Leads.**

## Section 11

### Reassembly

---

#### Prepare the Engine for Operation

The engine is now completely reassembled. Before starting or operating the engine, be sure to do the following.

1. Make sure all hardware is tightened securely.
2. Make sure the oil drain plugs, Oil Sentry™ pressure switch, and a new oil filter are installed.
3. Fill the crankcase with the correct amount, weight, and type of oil. Refer to oil recommendations and procedures in the "Safety and General Information" and "Lubrication System" sections.

#### Testing the Engine

It is recommended that the engine be operated on the test stand or bench prior to installation in the piece of equipment.

1. Set the engine up on a test stand. Install an oil pressure gauge in the location normally used for Oil Sentry™. Refer to "Lubrication System" section, Figure 6-6. Start the engine and check to be certain that oil pressure (20 psi or more) is present. Run the engine for 5-10 minutes between idle and midrange. Adjust the carburetor idle speed setting as necessary.
2. Make sure the maximum engine speed does not exceed 3750 RPM (no load). Adjust the throttle and choke controls and the high speed stop as necessary. Refer to the "Fuel System and Governor" section.

FOR SALES AND SERVICE INFORMATION  
IN U.S. AND CANADA, CALL  
**1-800-544-2444**

**KOHLER**<sup>®</sup>engines

ENGINE DIVISION, KOHLER CO., KOHLER, WISCONSIN 53044

FORM NO.:	TP-2480
ISSUED:	2/97
REVISED:	
MAILED:	3/97

LITHO IN U.S.A.